



INNWIND.EU Design Report

Reference Jacket

Agreement n.:	308974
Duration	November 2012 – October 2017
Co-ordinator:	DTU Wind

Support by:



PROPRIETARY RIGHTS STATEMENT

This document contains information, which is proprietary to the "INNWIND.EU" Consortium. Neither this document nor the information contained herein shall be used, duplicated or communicated by any means to any third party, in whole or in parts, except with prior written consent of the "INNWIND.EU" consortium.

Document information

Document Name:	Design Report – Reference Jacket
Document Number:	D4.3.1
Author:	Thomas von Borstel (Ramboll)
Document Type	Report
Dissemination level	PU
Review:	Björn Schümann (Ramboll)
Date:	31.10.2013
WP:	4
Task:	4.3
Approval:	Approved by WP Leader

1 TABLE OF CONTENTS

1	TABLE OF CONTENTS	3
2	INTRODUCTION.....	5
2.1	Purpose of this document	5
2.2	Approach.....	5
3	DESIGN CONSIDERATIONS	6
3.1	General	6
3.2	Structural constrains	7
3.3	Tower and Rotor-Nacelle-Assembly.....	8
3.4	Secondary Steel and grouted connections.....	8
3.5	Environmental Impact.....	10
3.5.1	Water Depth, Current and Marine Growth.....	10
3.5.2	Tidal Levels.....	10
3.5.3	Soil-Pile Interaction	10
3.5.4	Corrosion Allowance	11
3.6	Design Tools	12
3.6.1	Computer Program ROSAP	12
3.6.2	Computer Program LACflex	13
4	DESIGN PROCESS	14
4.1	General	14
4.2	Design Optimization.....	14
4.3	Limitations of this Study	14
4.4	Load Exchange	15
4.5	Design Load Cases.....	16
4.6	Ultimate Limit State (ULS)	16
4.6.1	General	16
4.6.2	Wave and Current Loading.....	17
4.6.3	Wind Loading	17
4.6.4	Extreme Event due to combined Wind and Wave	18
4.6.5	Wind and wave directions	18
4.6.6	Permanent Loading	18
4.6.7	Stress Check of Tubular Members.....	18
4.6.8	Punching Shear Check for Joints	18
4.7	Fatigue Limit State (FLS)	19
4.7.1	General	19
4.7.2	Wave and Current Loading.....	22
4.7.3	Wind Loading	22
4.7.4	Fatigue due to combined Wind and Waves.....	22
4.7.5	Wind and wave direction	23
4.7.6	Permanent Loading	23
4.7.7	Structural Damping.....	23

4.7.8	Equivalent Load Calculation.....	23
4.8	Natural Frequency Analysis (NFA)	24
4.8.1	General	24
4.8.2	Scenarios.....	24
4.8.3	Calculation method.....	24
5	RESULTS	25
5.1	Ultimate Limit State	25
5.1.1	Jacket	25
5.1.2	Tower	26
5.2	Fatigue Limit State.....	27
5.2.1	Jacket	27
5.2.2	Tower	28
5.3	Natural Frequency.....	28
5.3.1	Tower only	28
5.3.2	Total structure.....	28
5.4	Summary of Jacket Geometry and Masses	29
6	CONCLUSIONS AND OUTLOOK	30
6.1	Conclusion	30
6.2	Outlook	30
7	REFERENCES.....	32
	APPENDIX 1 – JACKET GEOMETRY	33
	APPENDIX 2 – TOWER GEOMETRY	39
	APPENDIX 3 – ULS UTILISATION-RATIOS.....	41
	APPENDIX 4 – FLS FATIGUE LIVES	46
	APPENDIX 5 – DESIGN LOAD CASES.....	53
	APPENDIX 6 – SOIL PROFILE	59
	APPENDIX 7 – SUPERLEMENT OF FOUNDATION (EXCLUDING TOWER).....	61

2 INTRODUCTION

2.1 Purpose of this document

This document provides information about the design of the Reference Jacket representing the state of the art design of a 4-legged, x-braced jacket structure supporting the 10MW InnWind Turbine, see ref. [9]. The Reference Jacket is supposed to serve as the structure all innovations developed throughout this project shall be measured against.

2.2 Approach

In a first step, the basis of the design had to be agreed on in order to define the loads and boundary conditions to be applied for the jacket structure. This data, summarized in the Design Basis document, ref. [8], depends to a great extent on the location of the foundation and includes environmental conditions like Metocean data. Furthermore, requirements of the structure like the corrosion protection and the marine growth have to be defined. In general, it is ensured that all design requirements defined in the Design Basis comply with the standard DNV-OS-J101, ref. [3].

Subsequently, the actual design process of the Reference Jacket has been split into two phases:

In phase 1 the jacket has been designed based on the maximum thrust at hub height and a modified version of an onshore tower, see ref. [9]. This preliminary version of the jacket was supposed to give a first indication of the jacket geometry and served as a starting point for the detailed wind load calculation explained in more detail in section 4.4.

In phase 2 the jacket has been refined and optimized (with regard to material) based on time-series wind loads combined with the hydrodynamic loads acting on the structure. The wind time-series loads have been calculated with the help of the aero-elastic tool LACflex. In this phase all requirements defined in the Design Basis have been taken into account. Throughout the optimization process it has been ensured that the design complies with the design requirements, namely Natural Frequency Analysis (NFA), Ultimate Limit State (ULS) and Fatigue Limit State (FLS) in accordance with the DNV standard, ref. [3].

The transition piece, which connects the tower bottom and the jacket legs, has not been designed in detail. However, reasonable assumptions have been made regarding its mass and stiffness properties.

The original tower provided by DTU has been checked for ULS as well as FLS and changes of the tower geometry have been made accordingly.

3 DESIGN CONSIDERATIONS

3.1 General

The general jacket foundation concept is characterized by a number of legs, which are stiffened by braces. The legs are supported by piles. The connection to the turbine tower is achieved through a transition piece, which is made of steel. For the present design, a four legged jacket with a generic strutted beam steel transition piece, four levels of X-bracings and four piles is used.

The jacket foundation as well as the tower is modeled with the Ramboll in-house FE-program ROSAP using tubular beam elements for the legs, braces and piles. Timoshenko beam theory is applied. The pile-soil interaction is modeled by means of soil springs in accordance with the API standard, ref. [5].

The elements connecting the jacket and the tower are modeled in ROSA as a strut model. This method leads to a simplification of the transition pieces mass and stiffness properties and could be evaluated in more detail. Ideally, a detailed FE-analysis of the transition piece should be conducted in order to optimize the structure. However, this is outside the scope of this study.

Figure 1 shows a 3-D model of a typical jacket foundation including sea, soil and appurtenances. The appurtenances are modeled as discrete or distributed masses, such as the boat landing, ladders, external J-tubes and anodes. Wave loads on appurtenances are calculated by the Ramboll in-house program ROSAP and are applied to the structure. Gravity and buoyancy loads are also taken into account for all structural analyses.

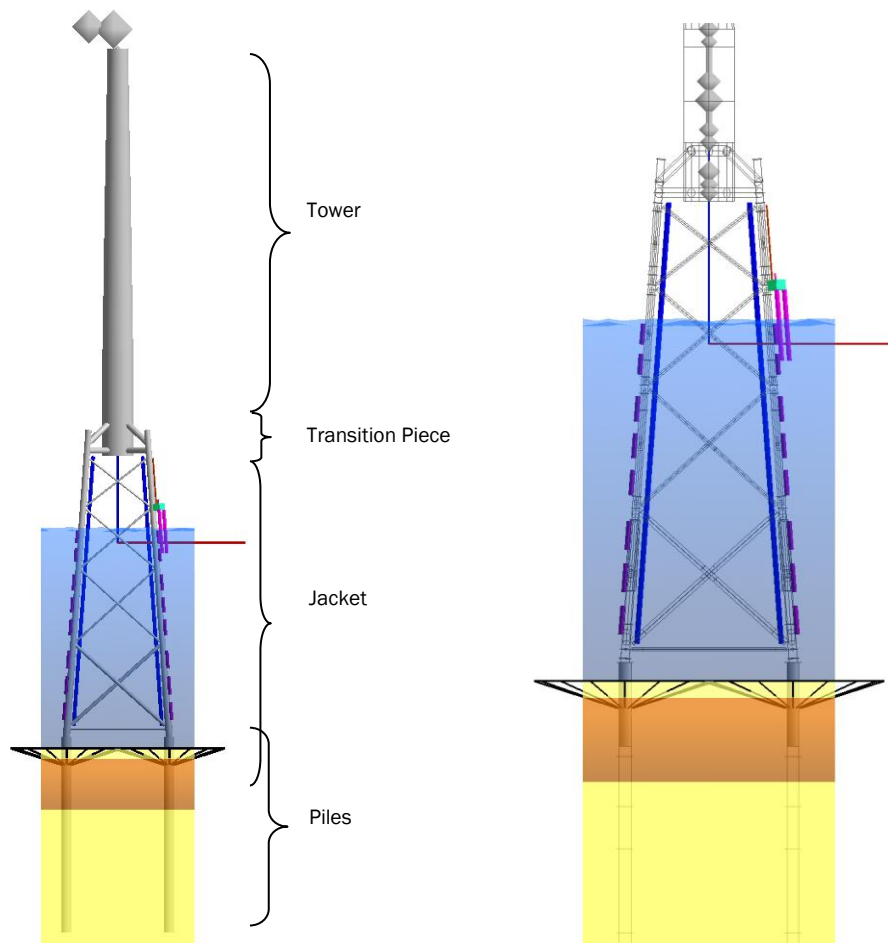

Figure 1: Overall view of the jacket model showing mass and area appurtenances.

The orientation of the jacket has been chosen such that the dominating wind and wave direction acts perpendicular to the flat side of the jacket. Hereby, waves are passing through the jacket legs and braces causing as less wave loading as possible.

3.2 Structural constrains

The X-braces are designed such that the angle between the brace and the leg is larger than 30 degrees, according to the NORSOK guidelines, see ref. [6]. Requirements from NORSOK concerning the minimum gap between braces at tubular joints (50 mm) and minimum distance between the brace-chord weld and the end of the can (the maximum of one fourth of the chord diameter or 300 mm) are also taken into account.

The following general rules for diameter/thickness ratio of tubular members shall aim at:

- D/t-ratio greater than 20 where practically possible, as the ratio of 20 corresponds to relatively thick tubular sections which demand mechanical tests to demonstrate that the steel retains its mechanical properties, ref. [6]
- D/t-ratio generally below 120 as specified by the NORSOK standard, ref. [6]

Conventionally, tubular joints are considered to be rigid in the global structural analysis of offshore platforms. However, research has revealed that the Local Joint Flexibility (LJF) tends to redistribute the nominal (global) stresses, increase the deformations, and change the natural frequencies and

mode shapes of the structure. Thus, LJF is taken into account in the NFA and FLS analysis of the jacket model. For ULS the LJF is neglected to avoid undesirable response of the joints when exposed to ultimate loading.

The bottom of the transition piece is located at a sufficient height so that it is not subjected to direct wave action considering the 50-years maximum wave crest and a certain air gap. Assuming a transition piece height of 9m, this leads to an interface elevation of 26m wrt. mean sea level, see the Design Basis [8].

3.3 Tower and Rotor-Nacelle-Assembly

The tower geometry is included in the ROSA model to reflect the correct dynamic response of the entire structure, see Appendix 2 – Tower Geometry. This includes masses and mass moments of inertia of the rotor-nacelle assembly.

The mass properties of the main rotor-nacelle-assembly (RNA) are provided based the DTU Reference Turbine Document, see ref. [9], and calculated for a single lumped mass by the aero-elastic tool LACflex, see Table 1. The geometry of the tower can be found in Appendix 2 – Tower Geometry.

The rotor-nacelle-assembly (RNA) is divided into two discrete subsystems, the rotor and the nacelle. The corresponding mass representation of the rotor and nacelle are applied according to the wind turbine manufacturer's specifications. These appurtenances are applied eccentric to the top node of the tower. Node appurtenances also include the mass moments of inertia for the different directions.

Table 1. *Rotor-Nacelle-Assembly Data, ref. [9]*

RNA at tower top	
Lumped Mass [kg]	676723
Moment of Inertia about x-axis [kg m ²]	1.66e8
Moment of Inertia about y-axis [kg m ²]	1.27e8
Moment of Inertia about z-axis [kg m ²]	1.27e8

3.4 Secondary Steel and grouted connections

The beam elements attract hydrodynamic loads based on the element diameter and hydrodynamic coefficients. The diameters are altered due to corrosion allowance and marine growth, see the Design Basis [8]. Furthermore, the beam elements can be treated as flooded or non-flooded members, hence decreasing or increasing the buoyancy of the structure. Only the legs are considered flooded.

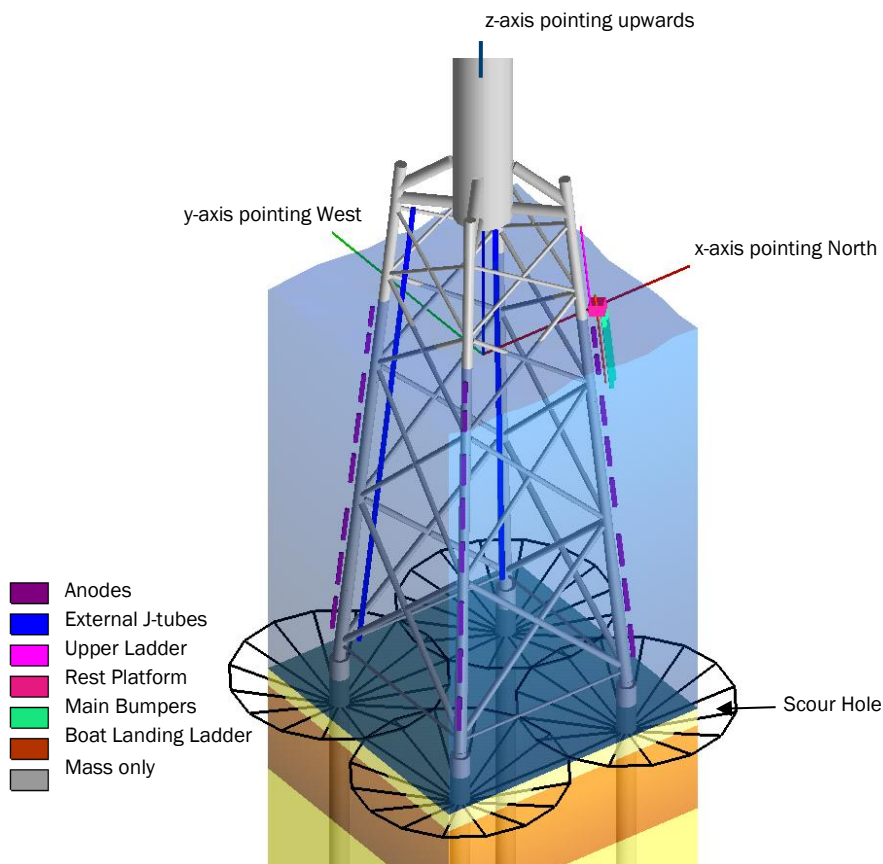

Figure 2: Overview of the jacket including appurtenances and local scour holes.

Secondary structures attached to the jacket are modeled as appurtenances in the ROSAP model in order to attract hydrodynamic loads for the global structure analysis.

The secondary structures include:

- Boat landing bumpers
- Access ladders
- Resting platform
- J-tubes
- Sacrificial anodes

Secondary steel on the foundation is included in the analyses by applying appropriate wave areas, masses and stress concentration factors, i.e. the additional loading from these structures are included.

The legs are located inside the piles and connected to these by means of a grouted connection. Figure 3 shows how one of the jacket legs is located inside the pile, which is the cause for the mud brace being at a high level above the seabed.

The link elements on the right side of Figure 5-3 indicate where the jacket legs and the piles are connected. All the loading from the jacket is fully transferred to the piles. Therefore, an infinitely stiff connection is integrated in the model allowing for a displacement and rotation transference between the legs and the main piles.

The diameter of the piles needs to be larger than the diameter of the legs for the pre-piled concept used in this study. Furthermore, the pile capacities must be sufficient to withstand all loads that the structure will experience. In addition, larger pile diameters are also beneficial with respect to forced bending deformations in the lower part of the jacket.

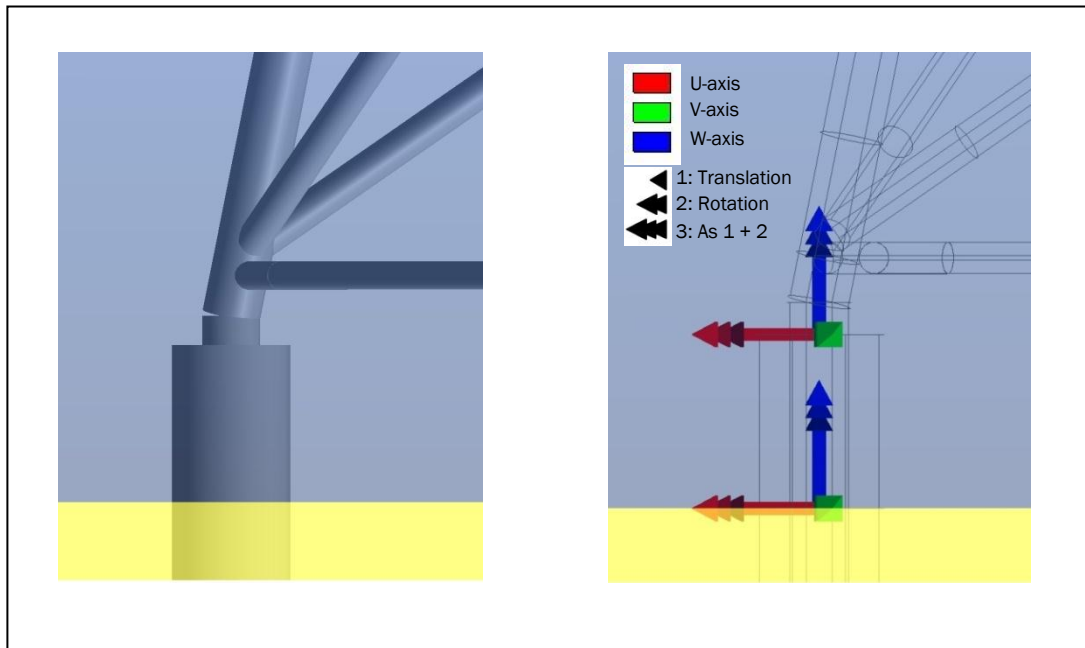

Figure 3: Part of the jacket model where leg and pile are connected.

3.5 Environmental Impact

3.5.1 Water Depth, Current and Marine Growth

The design water depth will be applied according to the Design Basis, ref. [8].

According to DIN EN 61400-3, ref. [2], extreme external conditions are assigned a recurrence period of 50 years as a sufficient conservative rule. Therefore, a variety of water levels will be applied in this analysis covering the 50 year tidal levels including the storm surge.

The current will be conservatively applied aligned with the waves and in accordance with the Design Basis, ref. [8].

Marine growth will be applied as stated in the Design Basis, ref. [8].

3.5.2 Tidal Levels

Tidal levels will be considered according to the Design Basis, ref. [8].

3.5.3 Soil-Pile Interaction

The response of the pile to loading is modeled using sets of springs to represent lateral resistance, skin friction and tip resistance, as shown in Figure 4. The load-displacement behavior of each set of springs is described by soil curves, which are summarized in Table 2.

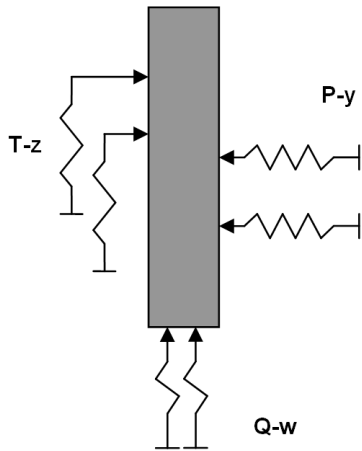

Figure 4: Soil response modeled using springs

Table 2. Summary of soil curves

Curve type	Mechanism represented
Q-w	Vertical loading: Tip resistance
T-z	Vertical loading: Skin friction
P-y	Lateral loading

The load-displacement curves are modeled according to API RP 2A-WSD, ref. [5]. The soil profile used in this study is shown in Appendix 6 – Soil profile.

3.5.4 Corrosion Allowance

An external corrosion allowance will be applied as stated in the Design Basis, ref. [8], corresponding to the value accumulated during the entire lifetime of the structure.

3.6 Design Tools

3.6.1 Computer Program ROSAP

ROSAP has been developed in-house as a tool to solve the problems commonly arising in analyses of fixed offshore steel platforms. During recent years the program package has been extended to solve problems regarding offshore wind turbine support structures. In this project ROSAP is used to design the jacket (and tower) structure.

The programs used in the present design are introduced and briefly described in the following.

WAVGEN: Wave kinematics generation program.

The program generates velocities, accelerations and excess pressures in a rectangular grid for waves and current, which can be used as input in ROSA and RONJA. A regular sea state can be generated according to a wave theory, e.g. Stokes' 5th order, sinusoidal or stream function waves. An irregular sea state can be generated according to a spectrum, e.g. Pierson-Moskowitz or JONSWAP spectra.

By discretizing the wave spectrum, free surface elevation time series are generated. The spectrum is discretized into a number of harmonic components in the frequency range 0-1 Hz. The discretization is performed with a constant frequency interval Δf , which allows the Fast Fourier Transform (FFT) technique to be applied. For each discrete frequency, the corresponding harmonic wave amplitude is determined.

In order to simulate an irregular sea surface, each harmonic component is assigned a random phase. One time series input will be generated for each analysed scatter group. The duration of this time series will be sufficiently long to allow for transient vibrations to be damped out.

The calculation of the velocities and accelerations is performed in the frequency domain by means of transfer functions applied on the free surface spectrum. Based on linear wave theory (1st order / Airy), the velocities and accelerations for each harmonic component are calculated in discrete points from mudline to the MSL. Time series of velocities and accelerations are generated by inverse FFT of the kinematic spectra. The discrete grid ranging from mudline to MSL, containing the kinematic components is afterwards modified by Wheeler stretching, in order to cover the full interval between mudline and the actual free surface.

ROSA: Static and dynamic analysis of space frame structures.

ROSA is a finite element program based on beam element and superelement formulations and is the main program of ROSAP. ROSA determines the deformations and sectional forces in the entire structure. Loads from gravity, buoyancy transport and environmental loads from waves and currents are generated automatically. Furthermore, load time series or deformations can be imported in the program and applied to the structure.

The hydrodynamic loads on the structure are calculated with the Morison equation using the input from WAVGEN. The hydrodynamic coefficients used in the Morison equation are determined for each part of the structure in accordance with user-specified input.

STRECH: Member stress check.

STRECH is a postprocessor to the ROSA program and it performs stress and stability checks of beam elements according to a user specified design code.

TUBJOI: Punching shear check.

The program is a postprocessor to the ROSA program and it is developed to perform the punching shear analysis of tubular joints in jacket structures according to a user specified design code.

FATIMA: Fatigue analysis program.

The program is a postprocessor to ROSA and it performs damage and fatigue life calculations of joints and beam elements defined in ROSA.

The program uses the stress ranges to calculate the fatigue damage at each stress point by a SN-curve approach.

The stress ranges are obtained by analysing the response of the structure for each load case defined in ROSA. Nominal stresses due to axial forces, in-plane and out-of-plane bending are calculated based on classical linear beam theory. Variations of the nominal bending stresses along the circumference of the element are considered by calculating the stress at a user defined number of section points.

Hot spot stresses at each of the section points are obtained by multiplying the nominal stresses by relevant stress concentration factors (SCF).

FATCOM: Fatigue damage combination program.

The program performs fatigue damage combination of damages stored in damage files from program FATIMA or other sources.

PREBOM: Pre-bill of material.

The program produces a bill of material and welding and weight reports.

The program also calculates gaps between braces at joints and performs a check of minimum lengths for cans and stubs at joints.

3.6.2 Computer Program LACflex

LACflex is an aero-elastic simulation program and is based on FLEX5 which is one of the most verified Aero-Servo-Elastic programs in the industry. It has been designed to model dynamic behavior of horizontal axis wind turbines.

The program runs in time-domain and produces time series of simulated loads and deflections. The structural dynamics are modeled using relatively few, but carefully selected, degrees of freedom using shape functions for the deflections of the tower and the blades, while using stiff bodies connected by flexible hinges to model the nacelle, rotor shaft and hub. The aerodynamic loads on the blades are calculated using the Blade-Element-Momentum method including dynamic stall and wake models. Mechanical, electrical and control systems are modeled in separate modules and can easily be customized according to clients' needs.

In this project LACflex is used to simulate the wind loads acting on the jacket and to provide the according time-series.

4 DESIGN PROCESS

4.1 General

The purposes and objectives of the different analyses performed in the course of this study are elaborated based on:

- Natural Frequency Analysis (NFA)
- Ultimate Limit State (ULS)
- Fatigue Limit State (FLS)

Transport, Vortex and Boat Impact analysis have been neglected.

The wind-induced design loads have been calculated with the help of the aero-elastic tool LACflex, while the hydrodynamic loads have been calculated with the Ramboll in-house software ROSAP.

4.2 Design Optimization

The reference jacket will be optimized in terms of material demand. Throughout the design process, all dimensions of the jacket (top width, bottom width, cross sectional properties of chords and braces) will iteratively be varied in order to achieve the lightest structure. This means that the wall thicknesses of the chord and brace cans will be designed individually for each K- and X-joint. In addition, each pipe connecting the nodes will be optimized individually in terms of weight.

4.3 Limitations of this Study

This study focuses on the natural frequency analysis, extreme load analysis and fatigue analysis. Further investigations such as driveability analyses, sea transportation, installation, vortex shedding and ship impact would be required in the course of a detailed design. However, this is outside the scope of the present study.

A few simplifying assumptions have been made. Conservatively, wind and wave have been assumed acting aligned in the fatigue and extreme event analysis. Furthermore, no inertia loads of the RNA induced by wave action have been considered. However, these assumptions are known to have a minor impact on the overall results.

The tower has been checked for ULS and FLS assuming it clamped at tower bottom. In a detailed design, the tower would have to be checked as part of the overall structure considering the inertia loads introduced by the wave action.

A detailed analysis of the steel/grout interaction in the overlap zone between jacket legs and piles has not been performed at this stage. In a detailed design of the jacket foundations, a detailed FE analysis should be performed to prove the capacity.

The steel transition piece needs to be designed in detail, including an FE analysis, and accurate values of the mass and stiffness properties. In this study mass and stiffness properties have been determined based on Ramboll's experience in similar projects.

Secondary steel has not been designed in detail, but it has been introduced for all analyses in order to capture the effects on loads, masses and stress concentrations at the attachments.

No driveability analysis has been performed for the piles.

4.4 Load Exchange

In the first design phase Ramboll generated a detailed model of the foundation based on the maximum thrust at the hub of the turbine, see ref. [9]. This model has been described in relevant aspects such as geometry, material properties and soil-structure interactions, ref. [10]. A superelement has subsequently been created by transforming the foundation into a reduced (generalized) foundation model (6x6 foundation system matrices) based on the GUYAN reduction, see ref. [13].

Subsequently, aero-elastic simulations of wind loads were performed with the help of LACflex using a model of the offshore wind turbine consisting of the rotor-nacelle-assembly (RNA), the tower and the superelement. The resulting dynamic responses at interface in terms of load time series of all six components (F_x , F_y , F_z , M_x , M_y and M_z) were extracted from LACflex and subsequently applied at the interface in a so-called 'Force Controlled' load calculation in order to obtain the dynamic responses of the foundation structure, see Figure 5. For a more detailed overview about the load exchange procedure see ref. [14].

For a detailed overview of the simulated design load cases see Appendix 5 – Design Load Cases.

For the ULS analysis, only the maximum wind loads have been extracted from the according design load case simulations and applied at interface in a static analysis. In contrast to ULS, the complete time-series loads have been applied in a dynamic FLS analysis accounting for directional probabilities.

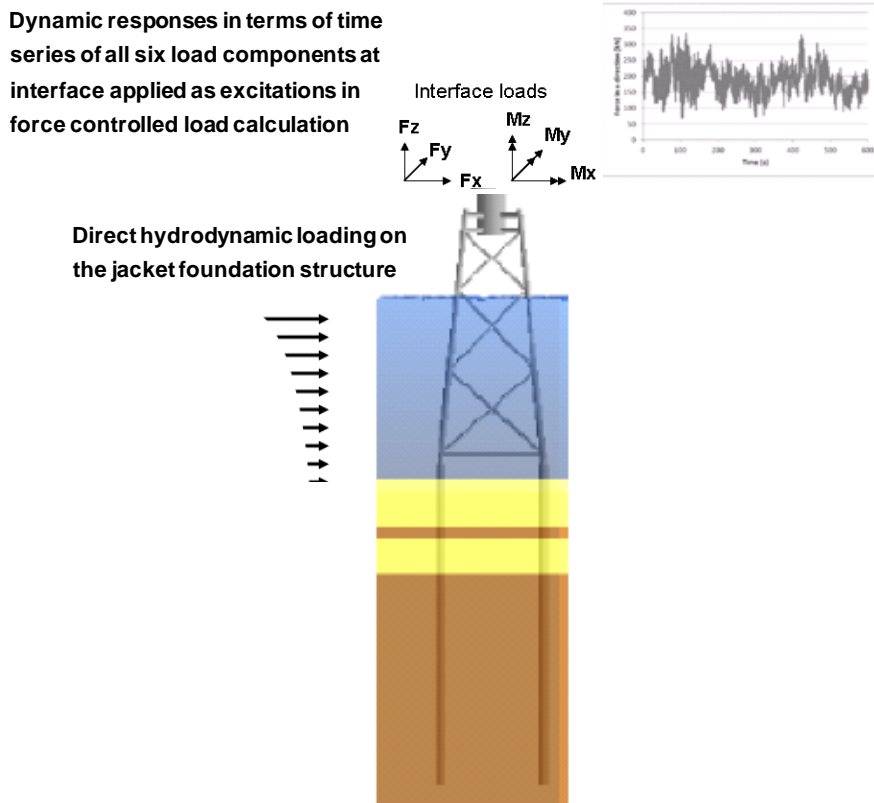

Figure 5: Application of wind time-series loads at interface together with hydrodynamic loads in a dynamic analysis.

4.5 Design Load Cases

All considerations regarding the design load cases are based on DIN EN 61400-3, ref. [2]. A 100 % availability of the turbine is considered for all load cases. Wind and wave are assumed to act aligned. The wind rose has been considered based on the local conditions and is stated in the Design Basis, ref. [8].

For **ULS** the DLC 2.1, 2.3, 6.1 and 6.2 are taken into account with 6 directions (half-cycle with 6 sectors and 30° steps). The following parameters have been considered when simulating the wind loads:

- 6 load directions
- 1 wind speed
- Yaw errors of -8°, 0° and +8°
- 6 seeds per scenario
- Randomly varying seeds

For **FLS** the DLC 1.2 & 6.4 are taken into account directional with a full cycle having 12 sectors and 30° steps. The following parameters have been considered when simulating the wind loads:

DLC 1.2

- 12 load directions
- 11 wind speeds (4, 6, 8, 10, 12, 14, 16, 18, 20, 22 and 24 m/s)
- Yaw error of -8°
- 2 seeds per scenario
- Randomly varying seeds
- A total of $12 \cdot 11 \cdot 1 \cdot 2 = 264$ files

DLC 6.4

- 12 load directions
- 2 wind speeds (2 and 30 m/s)
- Yaw error of -8°
- 2 seeds per scenario
- Randomly varying seeds
- A total of $12 \cdot 2 \cdot 1 \cdot 2 = 48$ files

A more detailed overview of the simulated design load cases can be found in Appendix 5 – Design Load Cases.

4.6 Ultimate Limit State (ULS)

4.6.1 General

The purpose of the extreme event analysis is to ensure that the jacket structure is capable of supporting the WTG for the least favorable combination of environmental load conditions, as presented in the Design Basis, ref. [8].

The extreme event analysis will be carried out using the Ramboll Offshore Structural Analysis Program, abbreviated ROSAP. The jacket will be considered for a number of different load combinations to produce the most severe loading on the structure. The following basic loads will be considered and combined in the extreme event analysis, based on section 7.3 in DIN EN 61400-3, ref. [2]:

- Gravitational and inertial loads

- Aerodynamic loads: Wind loads
- Hydrodynamic loads: Wave and current loads
- Hydrostatic buoyancy loads

The extreme event analysis comprises the Ultimate Limit State (ULS). Normal wind turbine loads (N) and well as abnormal loads (A) are considered in the ULS. All loads (including axial loads) are considered unfavourable in case of the stress check of tubular members and the punching shear check of joints. In case of the pile-soil utilization check, gravity loads are considered unfavourable for the piles under maximum compression and favourable for the piles under maximum tension.

Material safety factors are applied in accordance with the NORSOK standard, see ref. [6].

Table 3. *Partial load factors, ref. [2].*

Source of loading	ULS partial safety factor, γ_f				SLS, γ_f
	Unfavourable loads			Favourable loads	
	N Normal	A Abnormal	T Transport and erection	All design situations	
Environmental (wind, wave, current)	1.35	1.10	1.50	0.90	1.00
Gravity (& hydrostatic)	1.35	1.10	1.50	0.90	1.00

4.6.2 Wave and Current Loading

The wave loads on the jacket structure are computed based on Morison's equation and appropriate wave kinematics. The wave loads generated by ROSAP including wave dynamics by means of dynamic amplification factors are combined with wind load time series in a static analysis.

The wave load calculation on the structure will be performed for the load cases defined in DIN EN 61400-3, ref. [2], and summarized in section 4.5.

Conservatively, wave and current loads are assumed acting in the same direction. The variation in current profile with the water depth, e.g. due to wave action, will be accounted for by stretching/compressing the current profile in accordance with DIN EN 61400-3, ref. [2].

For the extreme event analysis, wave and current loads are based on the extreme waves, as provided in the Design Basis, ref. [8], and combined with wind loads derived from LACflex.

The hydrodynamic loads on the support structure are computed based on Morison's equation, which predicts hydrodynamic action in the ocean environment in an approximate sense. In brief, this equation accounts for local hydrodynamic drag and inertia actions, which can be characterized by hydrodynamic drag and inertia coefficients, C_d and C_m , respectively (together with density of water and local particle velocity of water).

Wave breaking is not considered for the extreme event in accordance with the Design Basis, ref. [8]. Wave run-up will not be considered.

4.6.3 Wind Loading

Wind loads from the turbine/tower structure are derived from the LACflex load calculation as probabilistic random loads based on time history assessment. The loads can be directly implemented in ROSAP for post processing.

The wind loading will be specified as load time series at the interface level. The calculation approach for such load input is based on wind load time series including dynamics (inertia loads) determined with the help of the LACflex simulation and provided corresponding to the interface elevation. The maximum absolute wind loads defined at interface are added to loads from irregular waves and the maximum combined loads are subsequently found. A more detailed description of this calculation approach can be found in section 4.4.

4.6.4 Extreme Event due to combined Wind and Wave

The static analysis is performed by means of ROSAP in a non-linear analysis. The dynamics of the wind loading are provided in time series from the LACflex simulation, and the dynamics from wave loading are included with dynamic amplification factors in the static analysis. In order to reduce conservatism, 80% of the maximum wind load is combined with 100% of the maximum wave load and vice versa. This accounts for the fact that the two extreme loads will not occur at the same time. The results of the analysis are node displacements and all sectional forces and moments in the entire modeled structure. The partial load factors are applied as stated in Table 3.

It is expected that the largest combined load can be found for aligned wind, wave and current condition. The most unfavourable conditions within the margins defined in DIN EN 61400-3, ref. [2], will be investigated and applied. For a detailed overview of the simulated load cases see Appendix 5 – Design Load Case.

4.6.5 Wind and wave directions

The wind and wave directions are applied in accordance with the Design Basis, ref. [8].

4.6.6 Permanent Loading

Permanent loads and buoyancy loads of the structure will be modelled as self-generated weight (dead weight) for all modelled tubular elements, i.e. jacket members, transition piece and tower structure. All other masses will be applied as appurtenances, see section 3.4.

The weight of steel included in the computer model is automatically generated in ROSAP. The permanent loads from tower and RNA are included in the wind loads.

4.6.7 Stress Check of Tubular Members

Tubular member stresses are checked by the ROSAP postprocessor STRECH, following the code checks outlined in NORSOK, see ref. [6]. The program optionally performs geometric analyses of X- and K-joints, and modifies the respective unbraced lengths (effective buckling lengths) in accordance with the axial forces of the adjoining members.

4.6.8 Punching Shear Check for Joints

The punching shear check for tubular joints is performed in accordance with the NORSOK standard, ref. [6]. The calculations are performed with the help of the ROSAP postprocessor TUBJOI.

4.7 Fatigue Limit State (FLS)

4.7.1 General

The purpose of the time domain fatigue analysis is to ensure that the jacket structure is capable of supporting the WTG for the required design life of 25 years.

The time domain fatigue analysis will be carried out using the Ramboll Offshore Structural Analysis Program, abbreviated ROSAP.

In addition, site specific conditions in terms of water depth and soil characteristics are applied for the turbine location, as specified in the Design Basis, ref. [8].

The design will be performed in accordance with the below given requirements and the fatigue lives are calculated by means of S-N curves using rain-flow counting on the stresses obtained from the dynamic analysis of the jacket support structure. The following requirements will be fulfilled:

- Partial safety factor for the loads will be taken equal to unity, while the partial safety factors for fatigue strength will be applied according to DNV-RP-C203, ref. [4].
- S-N curves displayed in Table 4 will be taken from DNV-RP-C203, ref. [4].
- The effect of misalignments such as fabrication eccentricity and steps in wall thickness is accounted for by means of Stress Concentration Factors, SCFs. For tubular butt weld connections this can be expressed in terms of the Maddox SCF formula according to DNV-RP-C203, ref. [4],

$$SCF = 1 + \frac{6e}{T_1} \left(\frac{1}{1 + \left(\frac{T_2}{T_1}\right)^{1.5}} \right)$$

where e is the wall centre line offset, T_1 is the thickness of the thinner plate and T_2 is the thickness of the thicker plate.

The eccentricity is then the sum of two different contributions:

- The distance between the centrelines of the two plates being welded together because of changes in wall thicknesses
 - Misalignment of the can sections, due to production tolerances.
- For tubular/conical transitions, the effect of misalignment is accounted for by means of a SCF for the tubular and cone side of the transition. According to DNV-RP-C203, ref. [4], these can be expressed as:

$$\text{Tubular side: } SCF = 1 + \frac{0.6t\sqrt{D_j(t+t_c)}}{t^2} \tan(\alpha)$$

$$\text{Conical side: } SCF = 1 + \frac{0.6t\sqrt{D_j(t+t_c)}}{t_c^2} \tan(\alpha)$$

where D_j is the cylinder diameter at junction, t is the tubular member wall thickness, t_c is the cone wall thickness, α is the cone angle, see figure on right.

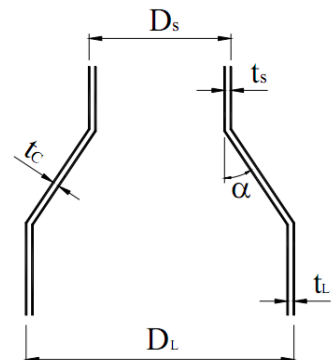

- Where no explicit formulations are found, relevant SCFs are calculated by means of appropriate Finite Element analyses (FEA)
- Tapering ratio of 1:4 will be applied for thickness transitions at circumferential welds on tubular sections.

- Weld improvement by means of grinding will be utilized if considered advantageous or necessary for girth welds. The extent of grinding will be agreed upon with the Client and all details where grinding is proposed will be identified and documented by Ramboll.
- The welds at tubular joints involve significant stress concentrations. These will be assessed using the equations provided by Efthymiou, ref. [11], for T, Y, DT, X, K and KT joint classes. Where this is not applicable, SCFs will be assumed based on experience. Welds at different structural parts will be checked as follows:
 - Joints: Checked as double sided welds (2-sided welds)
 - Jacket legs: Checked as double sided welds (2-sided welds)
 - Braces: Checked as single sided welds
- For welded attachments compression stresses will be reduced by the factor f_m , which will take values between 1.0 and 0.7, before used for fatigue damage calculation. If the material is in compression through a full load cycle the stress range $\Delta\sigma$, including possible SCFs, will be reduced to 0.7 whereas the factor is 1.0 if the material is in tension through a full cycle, i.e. no stress reduction. If the mean stress σ_m in a load cycle is in the range $\pm\Delta\sigma/2$ the factor f_m is interpolated linearly between 0.7 and 1.0 according to DNV-OS-J101, ref. [3].
- For cut-outs compression stresses will be reduced by the factor f_m , which will take values between 1.0 and 0.6, before used for fatigue damage calculation. If the material is in compression through a full load cycle the stress range $\Delta\sigma$, including possible SCFs, will be reduced to 0.6 whereas the factor is 1.0 if the material is in tension through a full cycle, i.e. no stress reduction. If the mean stress σ_m in a load cycle is in the range $\pm\Delta\sigma/2$ the factor f_m is interpolated linearly between 0.6 and 1.0 according to DNV-OS-J101, ref. [3]. Girth welds in the primary steel as well as tubular joints will be designed without any mean stress reduction in the calculated stress range.

The S-N curves stated in Table 4 will be applied in the analyses of the various points of interest in the structure.

Table 4. Applied S-N curves in accordance with DNV-RP-C203, ref. [4].

	Description	S-N Curve		Valid for
		In and below splash zone	Above splash zone	
1	Element Fatigue	DNV-D-W	DNV-D-A	Circumferential welds welded from both sides
		DNV-F-W	DNV-F-A	Circumferential welds welded from one side on a temporary or permanent backing strip without fillet welds
2	Tubular Joints	DNV-T-W	DNV-T-A	Circumferential welds welded from both sides
3	Attachment fatigue with SCF	DNV-D-W ¹⁾	DNV-D-A ¹⁾	Internally and externally
4	J-tube hole fatigue with SCF	DNV-B2-W ²⁾	DNV-B2-A ²⁾	Internally and externally

¹⁾ With appropriate SCF=1.61 as determined by FE analysis

²⁾ With appropriate SCF=2.50 as determined by FE analysis

For the circumferential single/double sided welds, the applied stress must include the stress concentration factor to allow for any thickness changes and fabrication tolerances. Due to less severe S-N curve for the outside weld toe than the inside weld root, 1-sided tubular butt weld

connections subjected to axial loading are designed such that any thickness transitions are placed on the outside. For this geometry, the SCF for the transition applies to the outside with the appropriate S-N curve as stated in Table 4. On the inside it is then conservative to use SCF of 1.0, see DNV-RP C203, ref. [4], for this matter.

It is emphasized that the fatigue damage of the tubular joints will be evaluated with the S-N curve defined in Table 4 in combination with maximum hot spot stress range at the weld toe based on the hot spot stress. The hot spot stress will be calculated using the equations provided by Efthymiou, ref. [11]. Use of the Efthymiou SCF equations is recommended because this set of equations is considered to offer either the best option or a very good option for most joint types and types of brace forces and is the only set which covers overlapped K- and KT-joints.

Consequently, the approach allows for incorporation of the effects of the overall geometry (structural or geometric stress concentration) and also includes the influence of the notch at the weld toe (local stress concentration), embedded in the appropriate S-N curve.

The required material factor for the individual parts of the support structure will be taken as shown in Table 5.

Table 5. Material factors for fatigue analysis, ref. [3].

	No access	In or below splash zone	Above splash zone
Material Factor	1.25	1.15	1.00

To minimise inspection requirements the material factor 1.25 will be applied everywhere for the jacket. The material factor will be applied to all stress ranges for calculation of design fatigue life. For the tower the material factor is set to 1.0.

4.7.2 Wave and Current Loading

Time series for the wave load will be generated in ROSAP according to the representative wave situations. A time-series realisation of each selected scatter group state (Direction, U_{hub} , H_s , T_p) will be performed by assuming that the spectral density of the wave elevation can be described by the JONSWAP wave spectrum, see DIN EN 61400-3, ref. [2].

By discretising the wave spectrum, free surface elevation time series will be generated. The spectrum will be discretised into a number of harmonic components in the frequency range 0-1 Hz. The discretisation will be performed with a constant frequency interval, Δf , which allows the Fast Fourier Transform (FFT) technique to be applied. For each discrete frequency the corresponding harmonic wave amplitude will be determined. In order to simulate an irregular sea surface, each harmonic component will be assigned a random phase. One time series will be generated for each analysed scatter group. The duration of this time series will be sufficiently long (650 seconds) to allow for transient vibrations from initialization of time integration to be damped out followed by 600 seconds.

The calculation of the velocities and accelerations will be performed in the frequency domain by means of transfer functions applied on the free surface spectrum. Based on the linear wave theory (airy), the velocities and accelerations for each harmonic component will be calculated in discrete points from mudline to mean sea level (MSL). Time series of velocities and accelerations will be generated by inverse FFT of the kinematic spectra. Afterwards, the discrete grid ranging from mudline to MSL and containing the kinematic components will be modified by Wheeler stretching to cover the full interval between mudline and the actual free surface, see DIN EN 61400-3 Annex C, ref. [2]

4.7.3 Wind Loading

Applying the superelement of the foundation as previously described, the wind loads are simulated LACflex and are provided as load time series at the interface (tower bottom) for substructure design. These load time series at interface accurately describe the dynamics of the combined loads as well as the damping.

4.7.4 Fatigue due to combined Wind and Waves

Wind and waves will be combined according to the process discussed in section 4.4. The wind response time series and the wave response time series (including dynamic effects), will be superimposed and subsequently post processed to determine the total fatigue damage during the simulated period of time (Rain-flow counting). Based on the yearly and directional probabilities of occurrence, the fatigue damage from the combined wind and wave simulation will be scaled to yearly damages.

As previously discussed, the fatigue damage will be determined using an S-N curve approach combined with appropriate stress concentration factors (SCFs). The cumulative damage will be determined based on a Miner's summation. Equally spaced stress points around the circumference of the tubular section will be considered. The number of spacing is usually taken as 8, 12 or 16 for the tubular joints with hot spots on both chord side and brace side. Nominal stresses due to axial forces, in-plane and out-of-plane bending moments will be calculated based on classical, linear beam theory. Variations of the nominal bending stresses along the circumference of the tubular section will be considered to follow a cosine variation.

Hot spot stresses at each of the stress points will be obtained by multiplying the above nominal stresses by stress concentration factors to obtain the hot spot stresses.

4.7.5 Wind and wave direction

Wind and wave will be considered acting aligned, which is a conservative assumption in case of jackets.

4.7.6 Permanent Loading

See section 4.6.6.

4.7.7 Structural Damping

The structural damping is assumed to be 0.5 percent of the critical damping.

4.7.8 Equivalent Load Calculation

For comparison/simplified benchmarking of the fatigue calculations, equivalent loads in the form of equivalent moments for each load case and in total will be reported together with the full fatigue results. The theory in the following subsection explains how these equivalent moments are calculated.

The equivalent moments will be stated at the interface node.

The purpose is to have generalized values that are more commonly used for comparison between results obtained by means of different methods and different software packages.

The dynamic analysis is performed in the in-house program ROSAP generating, among other data, the full stress history with a summary of the constant stress ranges obtained by means of rain-flow counting. The stress ranges, $\Delta\sigma_i = \sigma_{\max,i} - \sigma_{\min,i}$, are given with corresponding number of cycles, n_i , with i being the stress range index.

With this data, an equivalent stress range with a Wöhler slope of m and an equivalent number of cycles N_{eq} for a period of Y years may be expressed as:

$$\Delta\sigma_{eq} = \left(\frac{Y \sum_{i=1}^k n_i \Delta\sigma_i^m}{N_{eq}} \right)^{1/m}$$

The in house programs FATIMA and FATCOM, see section 3.6.1, are used to calculate the total pseudo-damage:

$$D_{pseudo} = \sum_{i=1}^k n_i \Delta\sigma_i^m$$

The equivalent moment can be expressed as:

$$M_{eq} = W \Delta\sigma_{eq}$$

Where W is the sectional modulus.

The damage equivalent moment based on the total pseudo-damage can finally be obtained as:

$$M_{eq} = W \left(\frac{Y D_{pseudo}}{N_{eq}} \right)^{1/m}$$

4.8 Natural Frequency Analysis (NFA)

4.8.1 General

The purpose of the analysis is to demonstrate that the natural frequency of the entire structure falls inside the allowable frequency band between 1P and 3P provided by the turbine document, ref. [9]. 1P is the lower limit corresponding to rotor frequency, $1P = (\text{rotor speed in rpm}) / 60$. 3P is the upper limit being the blade passing frequency, $3P = 3 \times (\text{rotor speed in rpm}) / 60$. A structure with stiffness in the range between the given limits refers to a soft-stiff structure.

As stated in the turbine document, ref. [9], the 1P range is between 0.10 - 0.16 Hz while the 3P range is between 0.30 - 0.48 Hz. Considering the effect of load amplification due to resonance effects near the 1P and 3P frequency, a safety margin of 10% is applied which leads to the "allowable" frequency range for the total structure: 0.176 - 0.273 Hz.

The obtained natural frequency of the system will be utilized in other analyses, such as the fatigue analysis, where the damping of the system is calculated by applying Rayleigh-damping. The natural frequency analyses (NFA) will be based on characteristic conditions, i.e. partial safety factors will be set to unity.

4.8.2 Scenarios

Two scenarios will be considered in the NFA in order to obtain a lower and an upper bound of the natural frequency. However, the natural frequency is expected not to vary significantly for the different scenarios, since it is the tower that governs the natural frequency of the overall structure.

Table 6. *Design scenarios to be checked for NFA*

Scenario	Seabed	Water level	Corrosion allowance	Marine growth
Stiff / Inflexible	Highest design elevation	LAT-Storm surge	No (0 mm)	No (0 mm)
Soft / Flexible	Lowest design elevation	HAT+ Storm surge	Full*	Full**
Fatigue	Highest design elevation	MSL	Half*	Full**

* Corrosion allowance will be applied according to the Design basis, ref.[8].

** Marine growth profile will be applied according to the Design basis, ref. [8].

4.8.3 Calculation method

Given the global stiffness matrix $[K]$ and the global mass matrix $[M]$, the angular frequencies corresponding to the natural periods and the mode shapes are determined by solution of the following eigenvalue problem:

$$([K] - \omega^2 [M]) \{v\} = \{0\}$$

In the above expression, the eigenvalues, ω , are used to determine the natural frequencies of the structural vibration, and the eigenvectors $\{v\}$ determine the shapes of these vibrational modes. The corresponding natural period is given by:

$$T = \frac{2\pi}{\omega}$$

Subspace iteration facilities inherent in the Ramboll's in-house calculation software ROSAP (Ramboll Offshore Structural Analysis Program) are applied to solve the eigenvalue problem expressed above.

5 RESULTS

5.1 Ultimate Limit State

5.1.1 Jacket

The extreme wind loads applied at the interface have been derived from the simulations performed with the help of LACflex. The setup for these simulations is summarized in Appendix 5 – Design Load Cases and the governing load cases are shown in Table 7. As described in section 4.6.4, 80 % of the maximum wind load has been combined with 100 % of the maximum wave load and vice versa in order to account for the stochastic character of turbulent wind and irregular waves.

Table 7. *Applied wind loads in ULS analysis at interface.*

Governing Load Component	DLC	Included Load Factor	V_{Res} [MN]	M_{Res} [MNm]	M_T [MNm]
Shear Force V_{Res} / Bending Moment M_{Res}	2.3	1.10	2.797	255.370	02.395
Torsional Moment M_T	1.2	1.35	1.141	128.427	49.189

Wind and wave impacting the support structure have been applied from directions parallel to the diagonal of the jacket footprint and perpendicular to the sides of the jacket structure, see Figure 6. This is considered as leading to the largest wave loads on the structure and thereby the highest ULS design requirements.

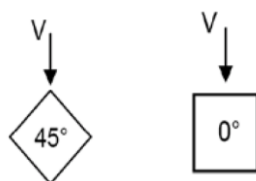

Figure 6: Wind & Wave directions considered in the ULS analysis

The tubular members of the jacket have been checked for stress and stability in accordance with NORSOK, ref. [6]. As can be seen from Table 8, all utilisation-ratios are below 1.0. A more comprehensive overview of the ULS utilisation-ratios of all tubular members can be found in Appendix 3 – ULS Utilisation-ratios.

Table 8. *Maximum utilisation-ratios of tubular members*

Component	Utilisation-ratio [-]
Legs	0.89
Braces	0.81
Piles	0.99

The punching check of all X- and K-joints is performed according to NORSOK, ref. [6]. Table 9 displays the maximum utilisation-ratios of all joints. A more detailed overview of the utilisation-ratios can be found in Appendix 3 – ULS Utilisation-ratios.

Table 9. *Maximum utilisation-ratios of joints.*

Component	Utilisation-ratio [-]
X-joints	0.54
K-joints	0.30

It is seen from the utilisation-ratios of the jacket braces, legs and the X-and K-joints that ULS is not governing the jacket design.

In order to determine the required penetration of all four piles, two checks have been conducted:

The first check is performed using plastic soil resistance taking into account the material safety factors for the soil parameters according to DNV [3]. By applying the maximum ULS wind and wave loads, the minimum pile penetration is found which ensures equilibrium between acting forces and withstanding forces. This pile penetration is found as soon as the ROSA calculation converges.

The second check is performed using characteristic soil conditions (setting all soil material safety factors to 1.0). The vertical and horizontal displacement of the pile top is plotted against the penetration depth and an asymptotic behaviour is observed. An abrupt deviation from this asymptote indicates large permanent settlements and a pull out of the piles, which is not acceptable for the verticality of the overall structure. A sufficient pile penetration is found at 40 m below mudline.

5.1.2 Tower

The tower has been checked against local buckling according to DIN EN 1993-1-6 [7]. The tower has been considered clamped at tower bottom. In a detailed design, the tower would have to be checked as part of the overall structure considering the inertia loads introduced by the wave action.

As can be seen from Table 11, the corresponding utilisation-ratios are below 1.0 for all sections. However, the original tower provided by DTU, ref. [9], had to be reinforced in its upper part due to local buckling criteria, see Appendix 2 – Tower Geometry.

The applied loads at tower top have been derived from the wind load simulations shown in Appendix 5 – Design Load Cases and the applied governing values can be found in Table 10.

Table 10. Applied wind loads in ULS analysis at tower top.

Governing Load Component	DLC	Included Load Factor	V_{Res} [MN]	M_{Res} [MNm]	M_T [MNm]
Shear Force V_{Res}	2.3	1.10	2.797	04.675	02.395
Bending Moment M_{Res}	1.2	1.35	0.992	52.124	04.936
Torsional Moment M_T	1.2	1.35	1.141	26.159	49.189

Table 11. Local Buckling check results according to DIN EN 1993-1-6, ref. [7].

Section Name	Unbraced Length of tower section [m]	Section-radius [m]	Wall Thickness [m]	Utilization-Ratio [-]
Bottom	31.700	3.833	0.034	0.874
Element1; top	31.700	3.733	0.034	0.803
Element 2; bottom	31.700	3.733	0.034	0.725
Element3; bottom	31.700	3.593	0.032	0.818
Element3; top	31.700	3.454	0.032	0.695
Element4; bottom	23.000	3.454	0.030	0.801
Element5; bottom	23.000	3.315	0.028	0.779
Element5; top	23.000	3.176	0.028	0.595
Element6: bottom	35.130	3.176	0.026	0.925
Element7; bottom	35.130	3.036	0.026	0.893
Element8; bottom	35.130	2.897	0.026	0.864
Element8; top	35.130	2.750	0.026	0.840

5.2 Fatigue Limit State

5.2.1 Jacket

The loads for the fatigue limit state analysis have been applied as outlined in section 4.7. The damage equivalent moment (DEM) at interface is shown in Table 12. It is used as a check in order to ensure that the time-series have been applied correctly. The validity of the FLS calculation is confirmed if the results derived from ROSA and LACflex match.

As can be seen from Figure 7 and Table 12, the fatigue loads significantly increase if the 1st natural frequency of the total structure approaches the lower 3P limit (0.3 Hz) of the turbine. As outlined in section 4.8.1, it is advisable to stay away from this 3P frequency; otherwise the loads will be amplified due to resonance effects.

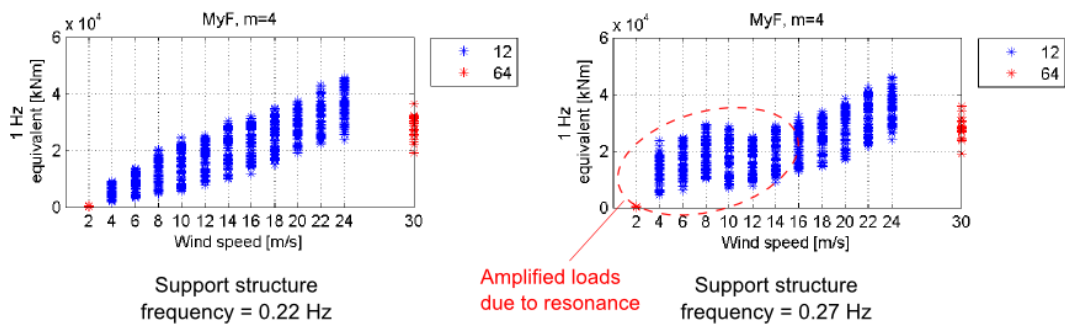

Figure 7: Damage equivalent moment and its amplification in case of a 1st natural frequency of the overall structure approaching the lower 3P limit (0.3 Hz).

On the other hand, a sufficient structural resistance of the jacket is required in order to withstand the loads; this is primarily achieved by increasing the bottom width of the jacket and thereby increasing the 1st natural frequency of the total structure.

To overcome this issue, the minimum rotor speed of the turbine could be increased in order to shift up the lower limit of the 3P frequency. In this case the bottom width of the jacket could be increased without causing an amplification of the loads due to resonance.

For the final result of the reference jacket, the loads derived from a jacket showing a 1st natural frequency of 0.267 Hz are used. However, these loads are applied to the final version of the jacket, see Appendix 1 – Jacket Geometry, which shows a 1st natural frequency of 0.285 Hz. This was done in order not to use loads which are being amplified due to resonance. It is noted that the validity of these wind loads is only guaranteed if the controller is changed, e.g. by increasing the minimum rotor speed and thereby shifting up the lower 3P limit.

Table 12. Impact of the natural frequency of the total structure on the damage fatigue loads at interface

Top width of Jacket [m]	Bottom width of jacket [m]	1 st natural frequency of total structure [Hz]	DEM [MNm] at interface for m=4; N=10 ⁷ and y=20 years
14	12	0.220	59
14	20	0.267	63^{**})
14[*])	34[*])	0.287[*])	73

^{*}) parameters referring to the final reference jacket geometry

^{**}) DEM representing the wind loads which have been applied on the final reference jacket

In order to ensure a minimum service life of 25 years, the fatigue life of all details (connections) is checked according to section 4.7.1. Table 13 shows the minimum fatigue lives which have been

observed in the total structure. A detailed overview of the fatigue lives is presented in Appendix 4 – FLS Fatigue Lives. It is noted that the fatigue of the K-joints is the most critical issue.

Table 13. Minimum Fatigue Life of the jacket components

Detail	Location	S-N curve	Minimum Fatigue Life [years]
2-sided circumferential welds	Legs	DNV-D	41
	Piles	DNV-D	101
1-sided circumferential welds	Braces	DNV-F	35
Attachments	Legs	DNV-D + SCF	47
J-tube hole	Legs	DNV-B2 + SCF	100
X-joints (as-build*)	Brace to Brace	DNV-T	29
K-joints (as-build*)	Brace to Leg	DNV-T	4

*) No grinding is considered.

5.2.2 Tower

The tower has been checked in accordance with DNV-RP C203, ref. [4]. The damage equivalent loads applied at tower top have been derived from the LACflex simulations. The corresponding load cases can be found in Appendix 5 – Design Load Cases. Only 2-sided circumferential welds have been checked applying the DNV-D curve. In addition, it should be noted that the material factor γ_m has been set to 1.0 in accordance with table J2 in DNV-OS-J101 [3], presuming the accessibility for inspection & repair of initial fatigue and coating damages.

Table 14. Damage equivalent loads applied at tower top

m=4; N=10 ⁷ ; y=20years	V _{Res} [MN]	M _{Res} [MN]	F _z [MN]	M _T [MN]
Tower Top	0.795	11.041	0.355	25.584

As can be seen from the results shown in Appendix 4 – FLS Fatigue Lives, all the tower sections show a sufficient fatigue life above 25 years. However, the original tower received from DTU, ref. [9], had to be reinforced in the bottom part due to FLS requirements, see Appendix 2 – Tower Geometry.

5.3 Natural Frequency

5.3.1 Tower only

The first 5 natural frequencies of the tower (including the RNA) considered clamped at interface (tower bottom) is displayed in Table 15.

Table 15. First 5 natural frequencies of the tower considered clamped at tower bottom (interface).

Mode	1 st Bending side-side	1 st Bending fore-aft	Torsion	2 nd Bending side-side	2 nd Bending fore-aft
Natural Frequency [Hz]	0.3246	0.3274	1.0298	1.7214	1.9024

5.3.2 Total structure

As can be seen from Table 16, the first natural frequency of the overall structure lies within the 1P – 3P frequency range. However, it does not lie within the “allowable” frequency range (0.176 – 0.273 Hz). Consequently, the present design of the structure leads to an amplification of the wind loads due to its natural frequency lying close to the 3P frequency of the turbine, see section 5.2.1. However, for the ULS and FLS design of the tower and the jacket the applied loads are based on a structure with a smaller first natural frequency which does not cause load amplifications. This presumes that controller changes will be made with respect to the minimum rotor speed, see section 5.2.1.

Table 16. First 5 natural frequencies of the total structure (considering fatigue conditions).

Mode	1 st Bending side-side	1 st Bending fore-aft	Torsion	2 nd Bending side-side	2 nd Bending fore-aft
Natural Frequency [Hz]	0.2867	0.2885	0.9358	1.1003	1.1133

5.4 Summary of Jacket Geometry and Masses

An overview of the jacket properties is provided in Table 17.

Table 17. Overview of jacket geometry and masses

Structural member	Dimensions	Value
Jacket		
Base Width	[m]	34
Top Width	[m]	14
Interface elevation	[m] wrt MSL	26
Transition Piece height	[m]	9
Batter angle of the legs	[°]	12.2
Number of legs		
	[-]	4
Jacket legs diameter (outer)	[mm]	1400
Jacket legs maximum wall thickness	[mm]	120
Jacket legs minimum wall thickness	[mm]	42
Number of x-braces levels		
	[-]	4
Max. Upper x-braces diameters (outer)	[mm]	900
Max. Upper x-braces wall thicknesses	[mm]	50
Max. Middle upper x-braces diameters (outer)	[mm]	876
Max. Middle upper x-braces wall thicknesses	[mm]	38
Max. Middle lower x-braces diameters (outer)	[mm]	968
Max. Middle lower x-braces wall thicknesses	[mm]	34
Max. Lower x-braces diameters (outer)	[mm]	1088
Max. Lower x-braces wall thicknesses	[mm]	44
Number of horizontal braces levels		
	[-]	1
Max. Horizontal braces diameter	[mm]	1044
Max. Horizontal braces wall thickness	[mm]	22
Number of Piles		
	[-]	4
Pile penetration	[m]	40
Pile diameter	[mm]	2438
Pile wall thicknesses	[mm]	32-52
Pile top elevation above mudline (Stick-up length)	[m]	1.50
Overlap length (grout length)	[m]	10.0
Mass		
Jacket structure	[t]	1210
Transition Piece (estimation)	[t]	330
Steel Appurtenances (estimation)	[t]	80
Piles (all)	[t]	380
Grout (estimation)	[t]	120
Total	[t]	2120
Natural frequency overall structure		
1 st eigenfrequency (1 st bending mode)	[Hz]	0.287

6 CONCLUSIONS AND OUTLOOK

6.1 Conclusion

The results of this study show that a state of the art jacket located at 50 m water depth with a 10MW turbine mounted on top causes some difficulties. These difficulties mainly refer to the high fatigue loads, the water depth of 50 m and the resulting low fatigue lives at the joints, especially at the K-joints near mudline which show a fatigue life considerably less than 25 years. A maximum wall thickness of 120 mm has been considered for the tubular members used for the jacket legs because this thickness is known to be a limit for the current fabrication of steel pipes and for avoiding brittle steel failure at low temperatures, see table A7 in DNV-OS-J101 [3].

Different jacket geometries have been evaluated in the course of this study. This included mainly the base width of the jacket, but also the number of braces and the angle of the braces. As can be seen in section 5.2.1, the wind loads show a significant dependence on the natural frequency of the overall structure: For a relatively stiff jacket the 1st natural frequency of the overall structure approaches the lower limit of the 3P frequency (0.30 Hz) imposed by the turbine; this leads to an increase of the wind loads compared to a softer jacket with a lower 1st natural frequency. However, decreasing the stiffness of the jacket decreases the wind fatigue loads, but it simultaneously reduces the structural resistance against these loads.

The present design of the structure leads to an amplification of the wind loads due to its first natural frequency (0.287 Hz) lying close to the 3P frequency (0,30 Hz) of the turbine, see section 5.2.1. However, for the ULS and FLS design of the tower and the jacket the applied loads are based on a structure showing a smaller first natural frequency which does not cause load amplifications. This presumes that controller changes will be made, e.g. with respect to the minimum rotor speed.

The mass of the jacket is 1210 tons while the mass of the transition piece is assumed to be 330 tons. The mass of all four piles add up to 380 tons. It is noted that it was not possible to the design the lower K-joints of the jacket for a fatigue life of 25 years. The transition piece mass has not been derived from a detailed FE analysis but appropriate assumptions have been made with respect to its mass and stiffness.

The tower has been checked for ULS and FLS. Minor reinforcements had to be made with respect to the wall thicknesses at the top and the bottom of the tower. It should be noted that the tubular sections of the tower would need further reinforcement if no accessibility for inspection & repair of initial fatigue and coating damages is assumed.

6.2 Outlook

Since the study shows that the jacket is driven mainly by fatigue of the tubular X- and K-joints, future investigations and improvements should focus on the mitigation on wind fatigue loads and on an increase of the fatigue resistance of X- and K-joints.

With respect to load mitigation, the rotor minimum speed could be increased in order to shift the lower limit of the 3P frequency upwards. This would decrease the wind loads even for jackets showing a 1st natural frequency close to 0.3 Hz. In addition, there are other load mitigation approaches existing which could offer an appropriate solution, see ref. [15].

Regarding the fatigue resistance of the X- and K-joints it might be an option to consider the use of Influence Matrices in order to calculate the hot spot stresses at the joints. The state of the art approach for considering these hot spot stresses is based on the Efthymiou equations, ref. [11]. However, this approach might yield too conservative results for the hot spot stresses at the legs.

Another option might be to consider casted joints instead of welded joints.

Furthermore, it could be investigated if there are possibilities to constantly reduce or remove the marine growth from the jacket braces. This would decrease the fatigue loads at the X- and K-joints.

The structural damping of the structure is assumed to be 0.5% of the critical damping. An increase of this damping (due to a more detailed analysis) would decrease the fatigue damage.

7 REFERENCES

Standards and codes

- [1] DIN EN 61400-1:2007-08: Wind Turbines – Part 1: Design Requirements (IEC 61400-1:2005); German version EN 61400-1:2005, Corrigenda to DIN EN 61400-1 (VDE 0127-1):2006-07.
- [2] DIN EN 61400-3:2010-01: Wind turbines – Part 3: Design requirements for offshore wind turbines (IEC 61400-3:2009).
- [3] DNV-OS-J101, Design of Offshore Wind Turbine Structures, Det Norske Veritas, January 2013.
- [4] DNV-RP C203: 2012-10 DNV Recommended Practice – Fatigue Design of Offshore Steel Constructions.
- [5] API RP 2A-WSD: Recommended Practice for Planning, Designing and Constructing Fixed Offshore Platforms – Working Stress Design. 21. Edition, 1. December 2000. Including Errata and Supplement 3, October 2007.
- [6] NORSOK N-004: Design of Steel Structures. NORSOK Standard N-004, Rev. 2, October 2004.
- [7] DIN EN 1993-1-6:2007 + AC:2009. Strength and stability of shell structures, December 2012.

Project-specific documents

- [8] InnWind Design Basis. Ramboll document, Rev0, XX/XX/201X, **PENDING**.
- [9] DTU10MW Reference Turbine Data Sheet. DTU excel-sheet, version 1.04, 11/05/2013.
- [10] Interface Document for Preliminary Jacket Design, Ramboll document 341_0001(2), Rev.02, May 2013.

Scientific papers

- [11] Efthymiou, M.: Development of SCF formulae and generalized influence functions for use in fatigue analysis. Recent Developments in Tubular Joint Technology, OTJ'88, October 1988, London.
- [12] J. Buitrago, B. Healy and T. Chang: Local Joint Flexibility of Tubular Joints, OMAE article 1993.
- [13] Guran, R.J.: Reduction of Stiffness and Mass Matrices. AIAA Journal, Vol. 3, No. 2, 1965.
- [14] Passon, P. and Branner, K.: Load calculation methods for offshore wind turbine foundations. Ships and Offshore Structures, Vol. 8, Taylor & Francis, 2013.
- [15] Fischer, T.: Mitigation of Aerodynamic and Hydrodynamic Loads of Offshore Wind Turbines, Shaker Verlag, 2012.

APPENDIX 1 – JACKET GEOMETRY

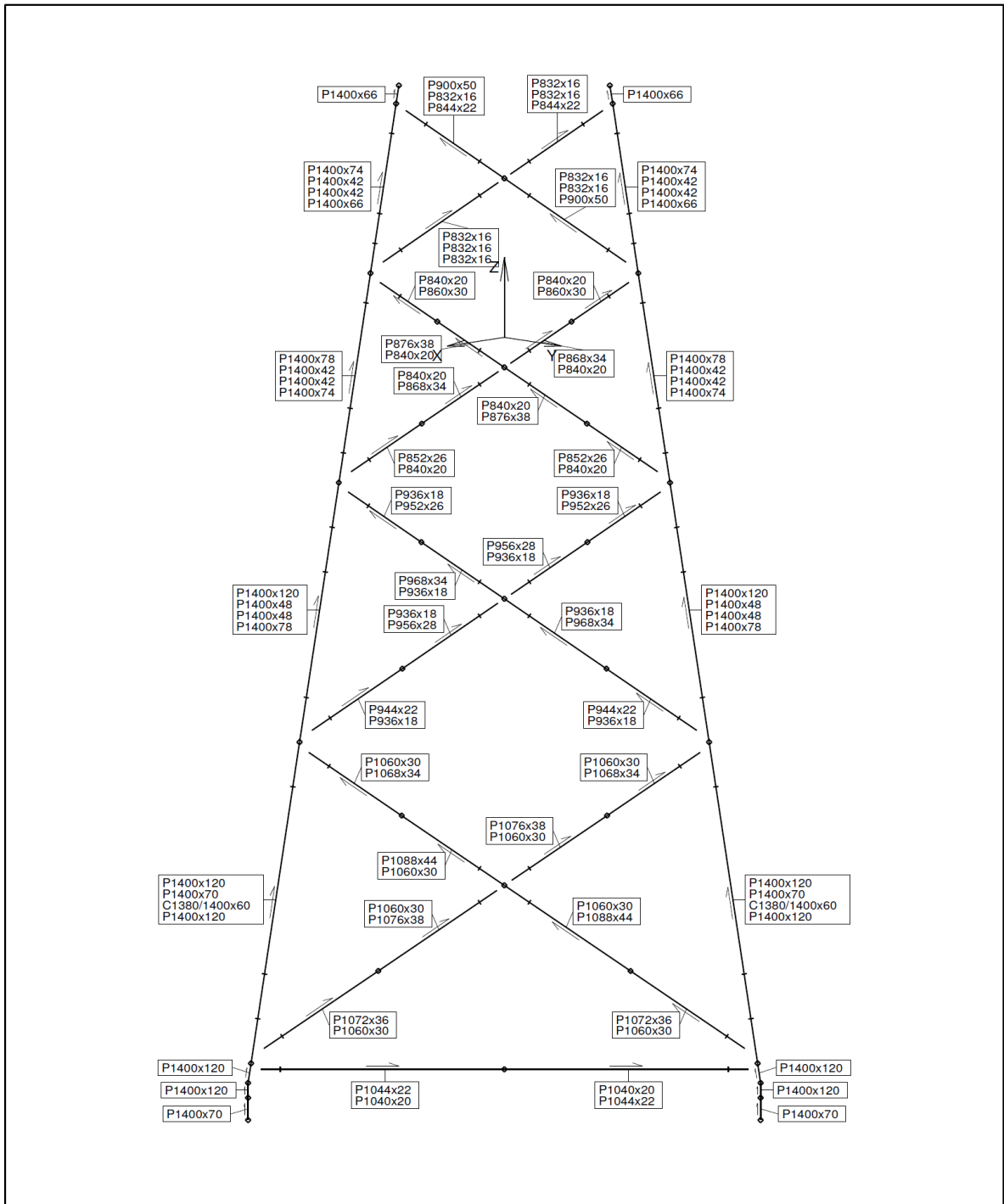

Jacket Side A - View from outside jacket

Ramboll Wind

Direction:	X:-0.699	Y:-0.699	Z:-0.151
Limits:	X(0.000, 24.042)	Y(0.000, 24.042)	Z(-50.000, 18.000)
Plot 1:	Date: 2013-10-17	Time: 15:24:49	Job OPPKMS (STPLOT 4.7)

COMPANY: InnWind
 PROJECT: Reference Jacket
 SUBJECT: 4-LEG, 4-STOrey, STIFFEST CONFIG

Hannemanns Alle 53 Tel: +45 5161 1000 Web: www.ramboll.com/wind
 DK 2300 Copenhagen S Fax: +45 5161 1001 Email: info@ramboll.com

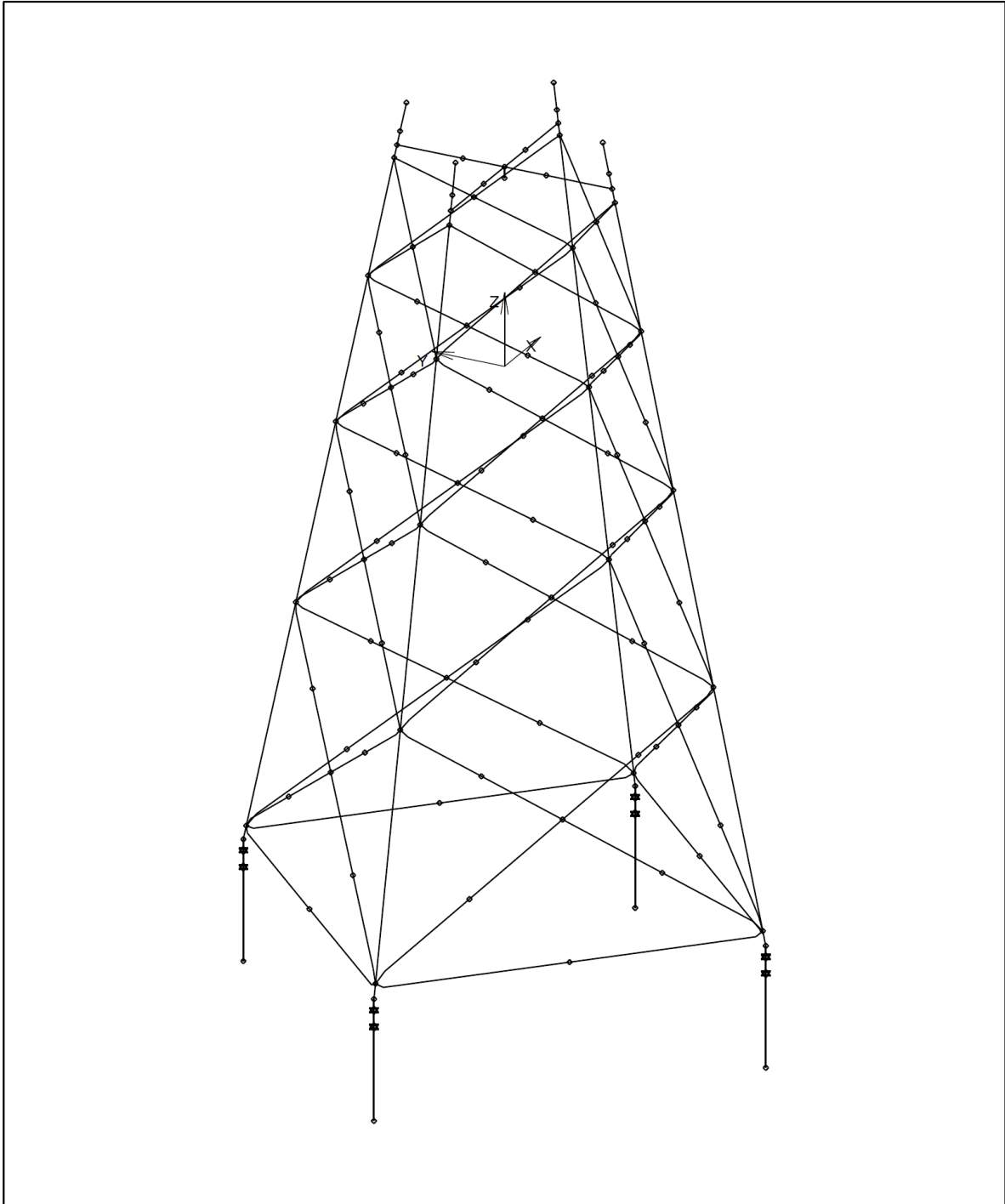

General view of Jacket

Ramboll Wind

Direction:	X: 0.816	Y: 0.408	Z: -0.408
Limits:	X(-24.042, 24.042)	Y(-24.042, 24.042)	Z(-58.500, 22.000)
Plot 5:	Date: 2013-10-17	Time: 15:24:49	Job OPPKMS (STPLOT 4.7)

COMPANY: InnWind
 PROJECT: Reference Jacket
 SUBJECT: 4-LEG, 4-STOREY, STIFFEST CONFIG

Hannemanns Alle 53
 DK 2300 Copenhagen S

Tel: +45 5161 1000
 Fax: +45 5161 1001

Web: www.ramboll.com/wind
 Email: info@ramboll.com

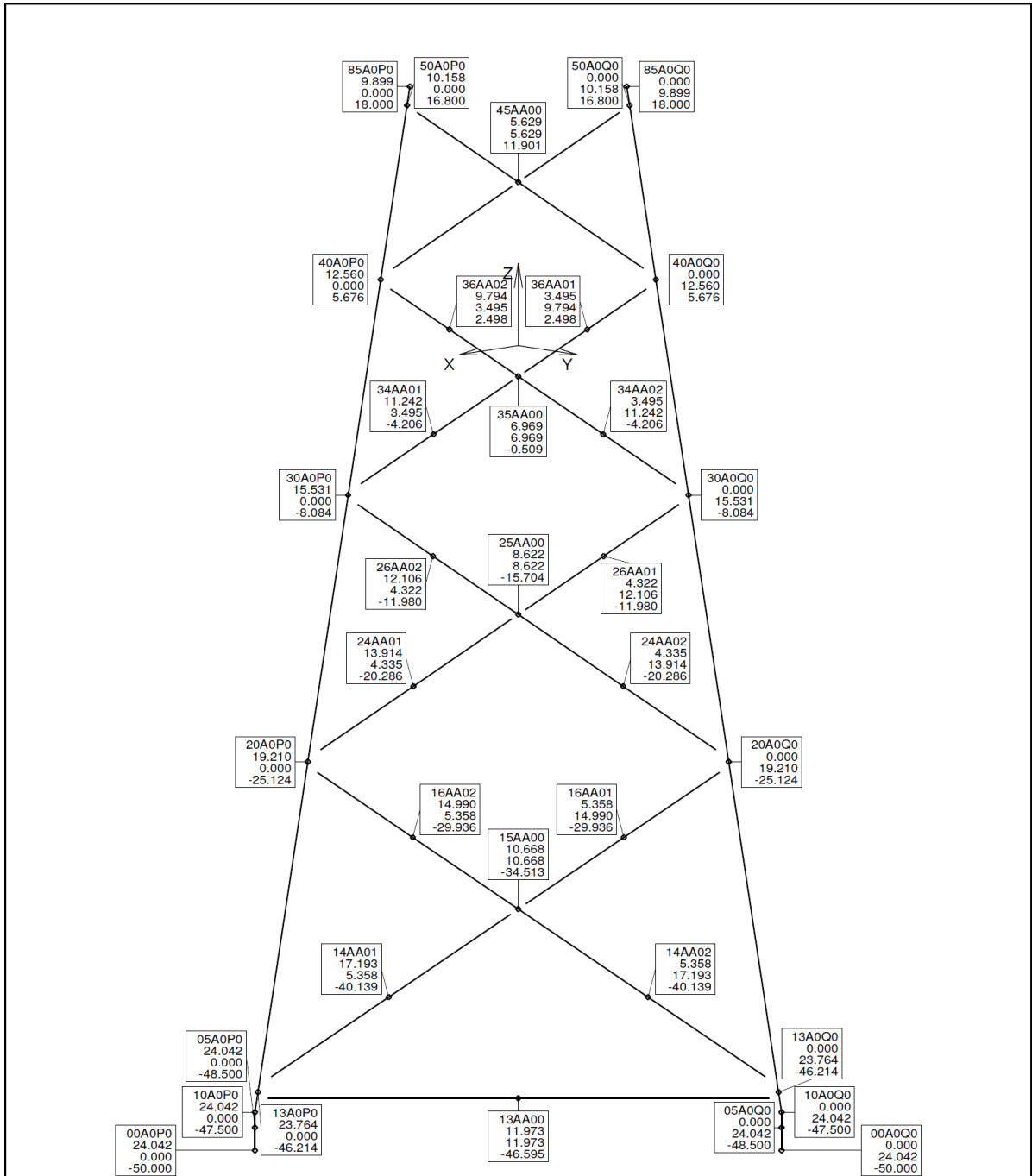

Node coordinates (m)
Jacket Side A - View from outside jacket

Ramboll Wind

Direction:	X: -0.699	Y: -0.699	Z: -0.151
Limits:	X(0.000, 24.042)	Y(0.000, 24.042)	Z(-50.000, 18.000)
Plot 1:	Date: 2013-10-17	Time: 15:24:49	Job OPPKMS (STPLOT 4.7)

COMPANY: InnWind
PROJECT: Reference Jacket
SUBJECT: 4-LEG, 4-STOERY, STIFFEST CONFIG

Hannemanns Alle 53
DK 2300 Copenhagen S

Tel: +45 5161 1000
Fax: +45 5161 1001

Web: www.ramboll.com/wind
Email: info@ramboll.com

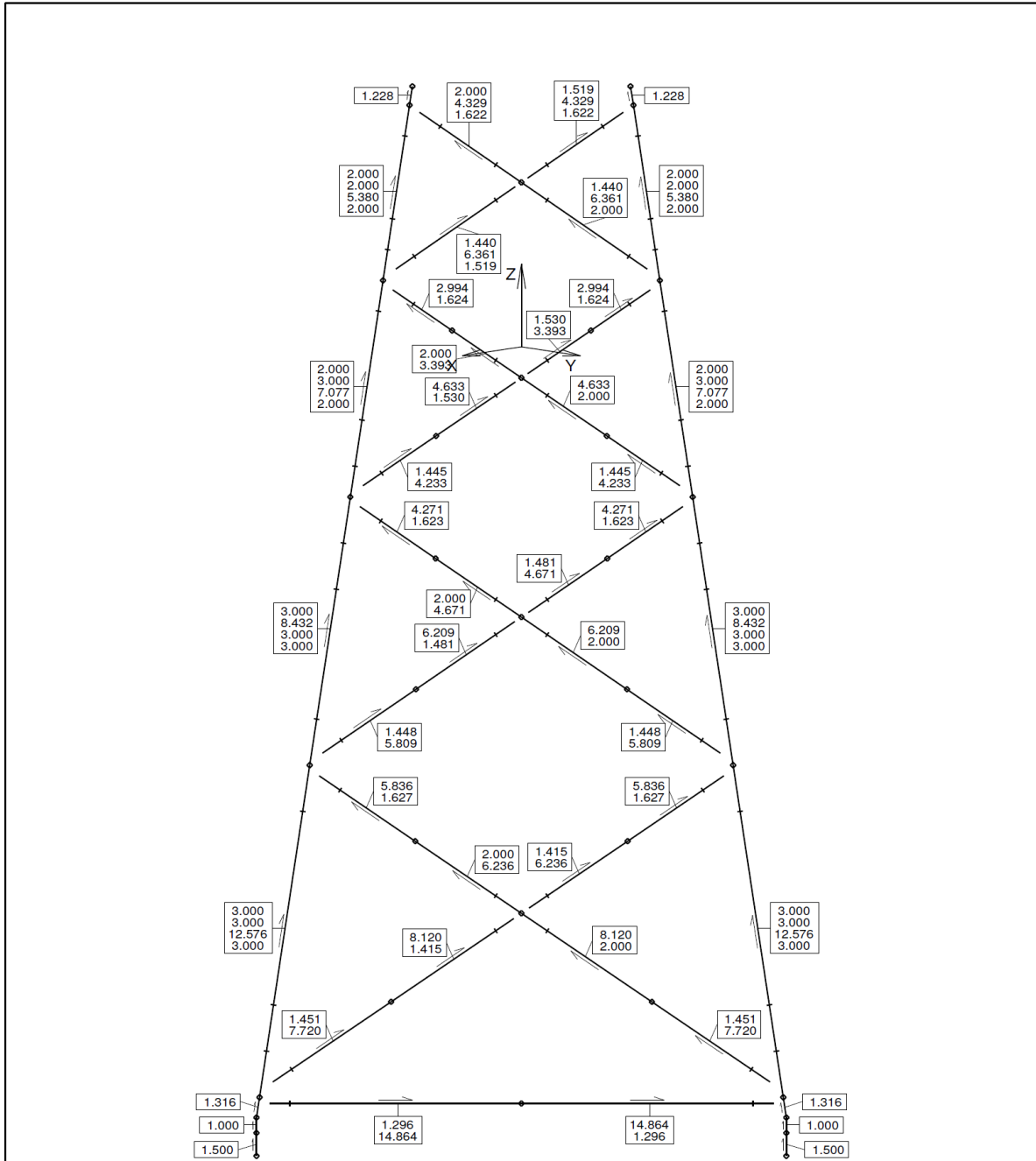

Element Lengths
Jacket Side A - View from outside jacket

Ramboll Wind

Direction:	X:-0.699	Y:-0.699	Z:-0.151
Limits:	X(0.000, 24.042)	Y(0.000, 24.042)	Z(-50.000, 18.000)
Plot 1:	Date: 2013-10-17	Time: 15:24:49	Job OPPKMS (STPLOT 4.7)

COMPANY: InnWind
PROJECT: Reference Jacket
SUBJECT: 4-LEG, 4-STOREY, STIFFEST CONFIG

Hannemanns Alle 53 DK 2300 Copenhagen S	Tel: +45 5161 1000 Fax: +45 5161 1001	Web: www.ramboll.com/wind Email: info@ramboll.com
--	--	--

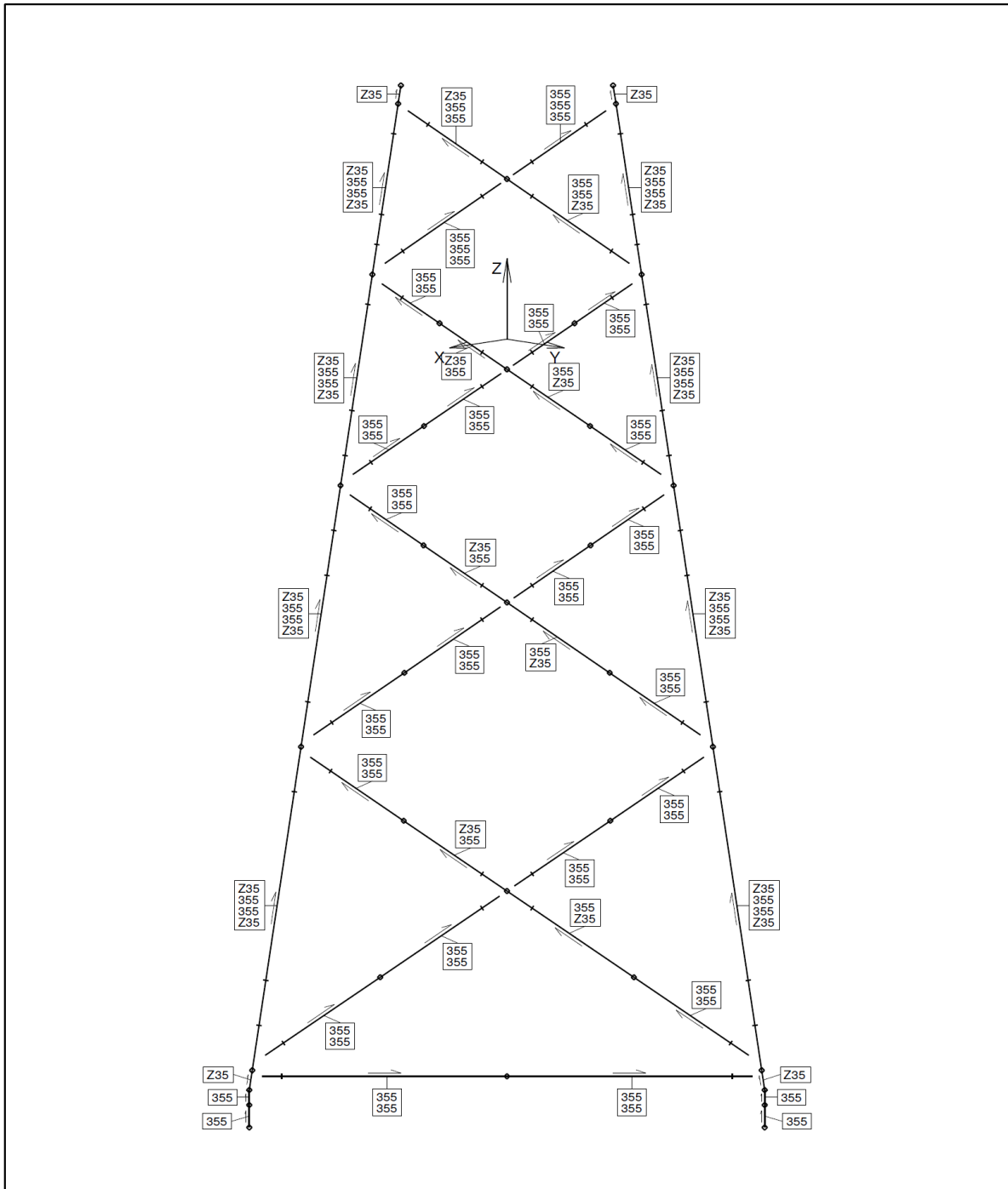

Material Names
Jacket Side A - View from outside jacket

Ramboll Wind

Direction:	X:-0.699	Y:0.699	Z:-0.151
Limits:	X(0.000, 24.042)	Y(0.000, 24.042)	Z(-50.000, 18.000)
Plot 1:	Date: 2013-10-17	Time: 15:24:49	Job OPPKMS (STPLOT 4.7)

COMPANY: InnWind
PROJECT: Reference Jacket
SUBJECT: 4-LEG, 4-STOREY, STIFFEST CONFIG

Hannemanns Alle 53
DK 2300 Copenhagen S

Tel: +45 5161 1000
Fax: +45 5161 1001

Web: www.ramboll.com/wind
Email: info@ramboll.com

APPENDIX 2 – TOWER GEOMETRY

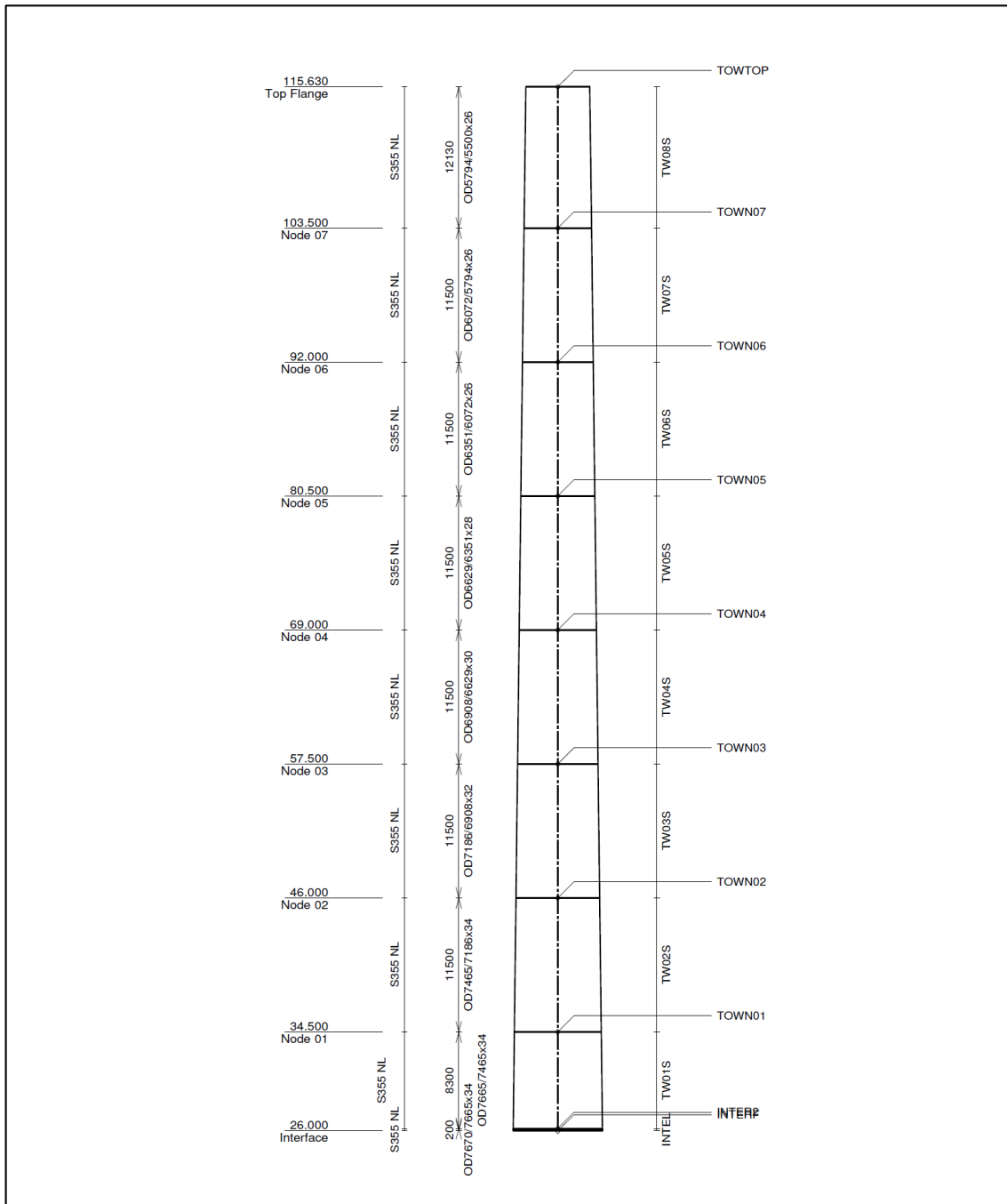

NOTES						
1. All dimensions in millimeters.						
2. All levels in meters.						
3. Nominal weight of steel on this drawing: S355 NL 429.23 tonnes						
Rev.	Date	Drw.	Chkd.	Appr.	Description	
0	2013.10.15	TVB	BJOS	TIMF	Issued for information	
Client						
InnWind						
Ramboll Wind						
Reference Jacket						
Title						
InnWind Tower						
Scale	Size	Drawing No.				Rev.
1:467	A4	For information				0



APPENDIX 3 – ULS UTILISATION-RATIOS

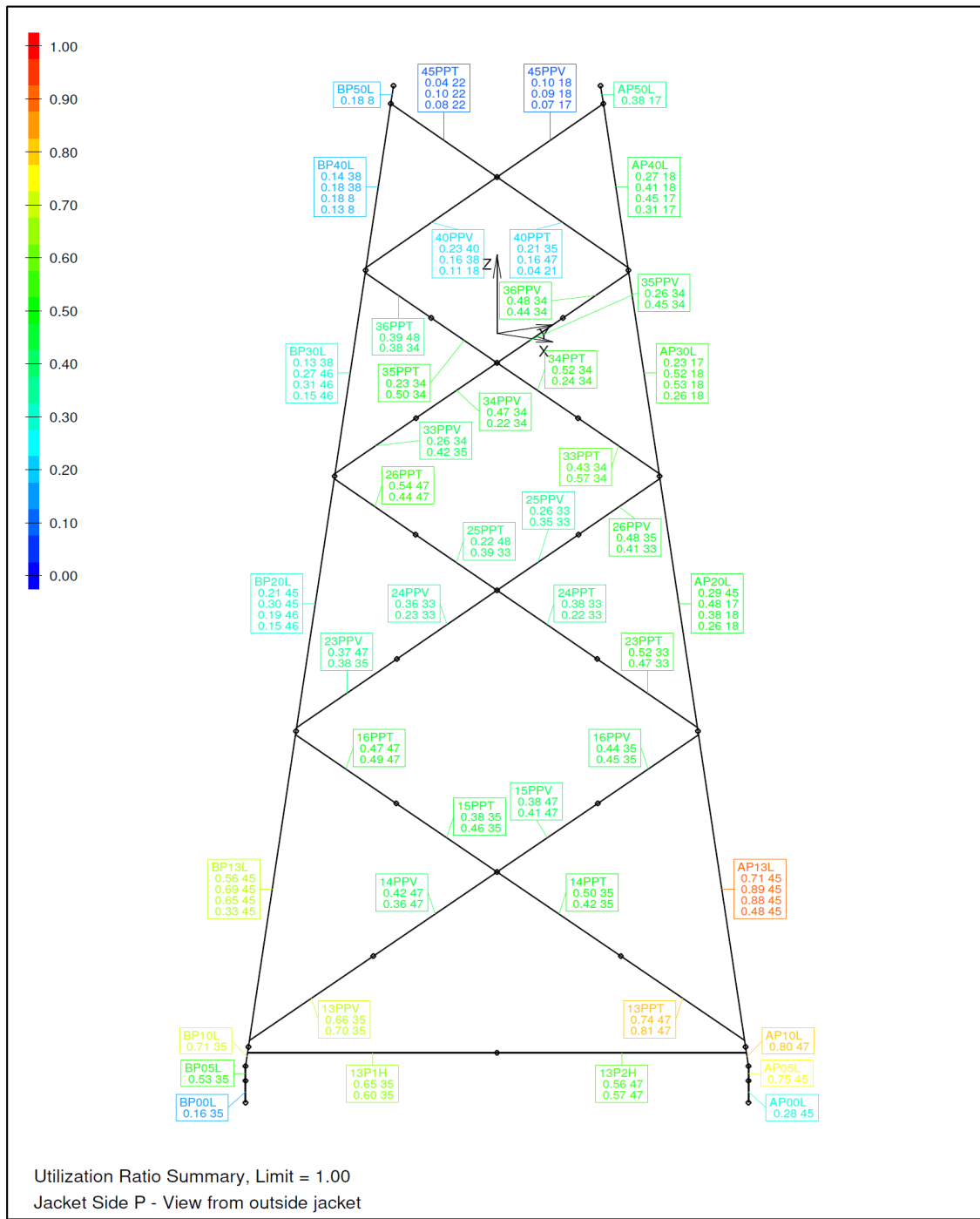

Ramboll Wind

Direction:	X: -0.699	Y: 0.699	Z: -0.151
Limits:	X(-0.000, 24.042)	Y(-24.042, 0.000)	Z(-50.000, 18.000)
Plot 3:	Date: 2013-10-31	Time: 16:49:19	Job PJQUWB (STPLOT 4.7)

COMPANY: InnWind
PROJECT: Reference Jacket
SUBJECT: 4-LEG, 4-STOREY, Characteristic soil , LOWEST WATER LEVEL , 40.00

Hannemanns Alle 53
DK 2300 Copenhagen S

Tel: +45 5161 1000
Fax: +45 5161 1001

Web: www.ramboll.com/wind
Email: info@ramboll.com

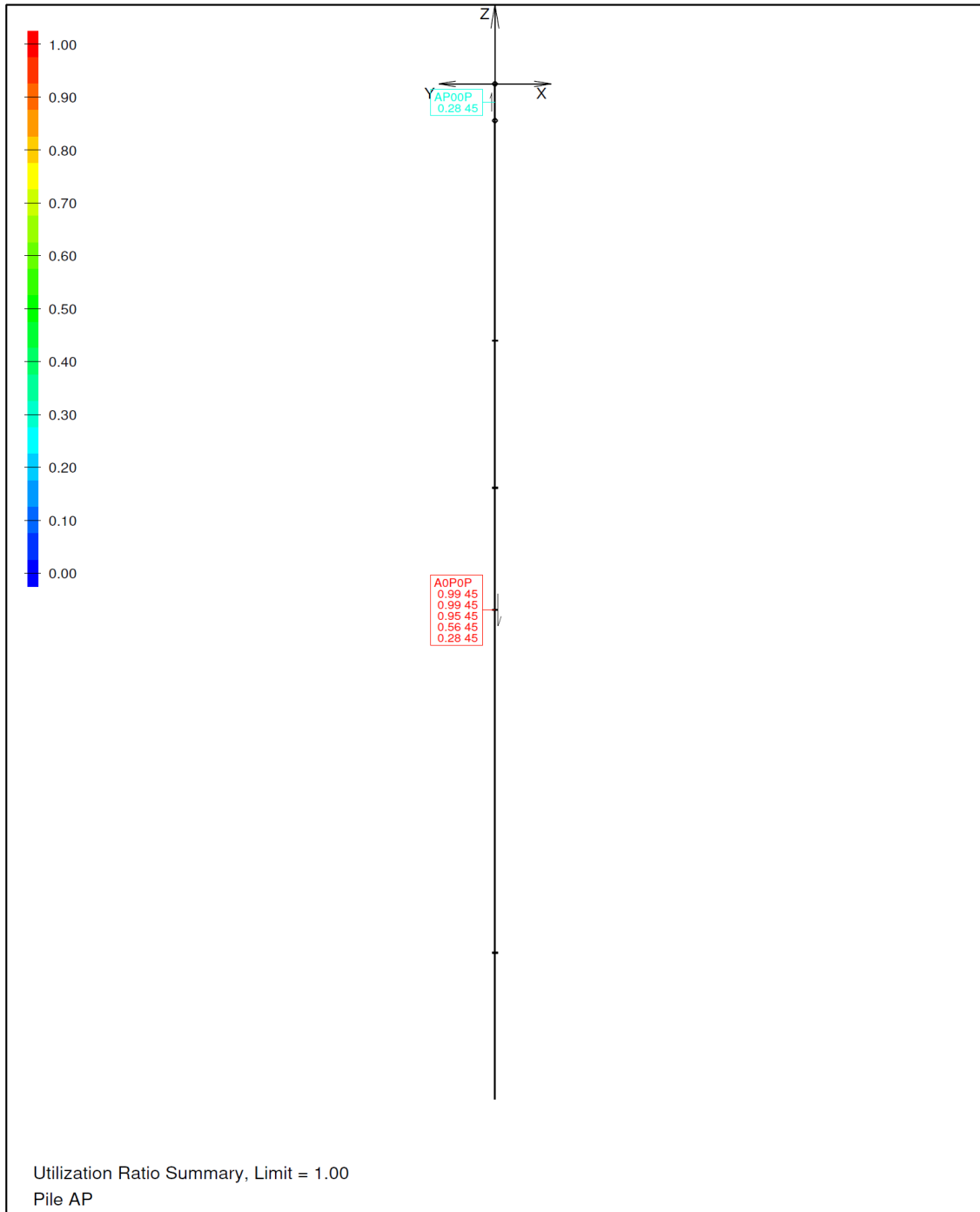

Ramboll Wind

Direction:	X: 0.707	Y: 0.707	Z: 0.000
Limits:	X(24.042, 24.042)	Y(0.000, 0.000)	Z(-90.000, -48.500)
Plot 6:	Date: 2013-10-31	Time: 16:49:19	Job PJQUWB (STPLOT 4.7)

COMPANY: InnWind
PROJECT: Reference Jacket
SUBJECT: 4-LEG, 4-STOREY, Characteristic soil , LOWEST WATER LEVEL , 40.00

Hannemanns Alle 53
DK 2300 Copenhagen S

Tel: +45 5161 1000
Fax: +45 5161 1001

Web: www.ramboll.com/wind
Email: info@ramboll.com

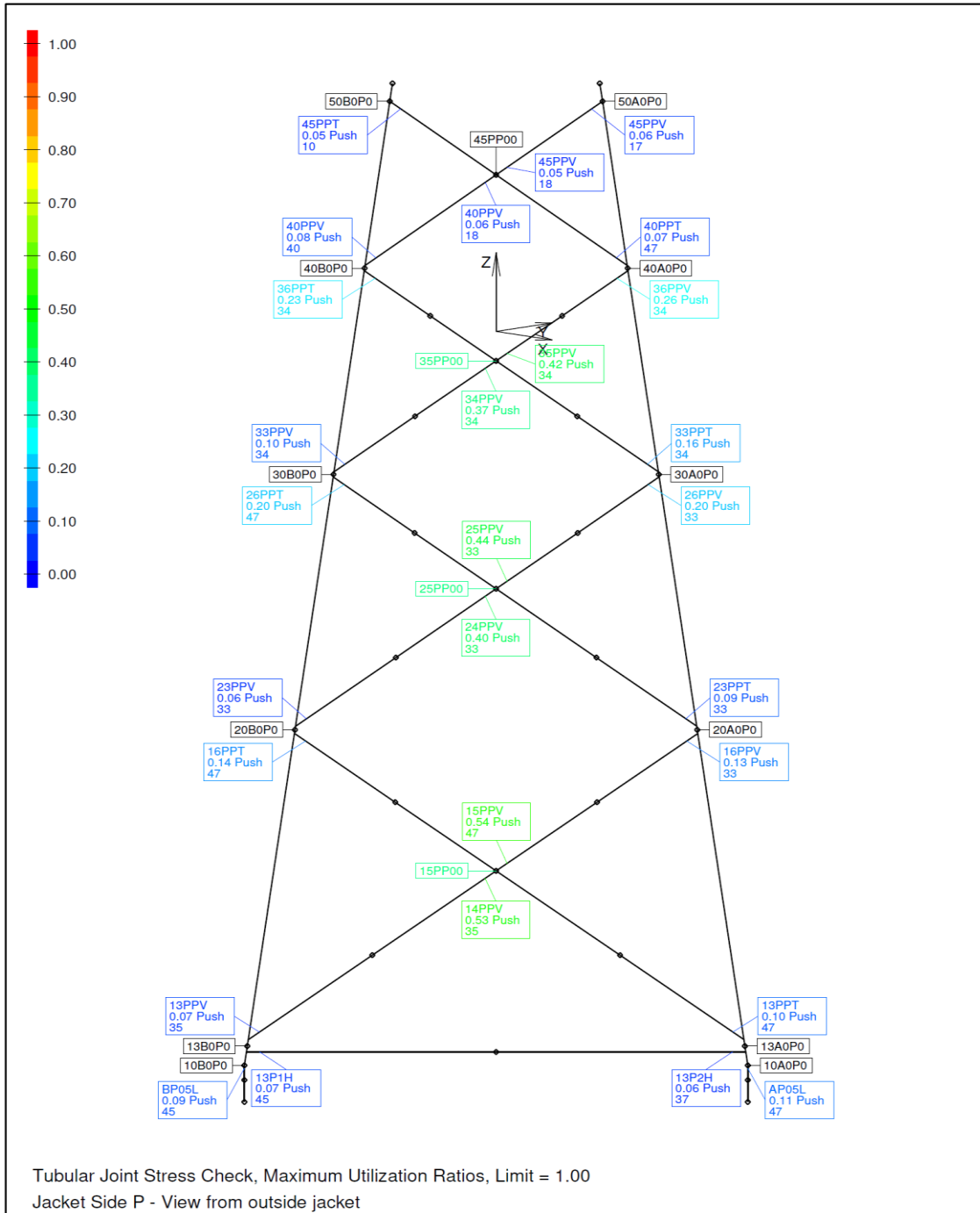

Tubular Joint Stress Check, Maximum Utilization Ratios, Limit = 1.00
Jacket Side P - View from outside jacket

Ramboll Wind

Direction:	X: -0.699	Y: 0.699	Z: -0.151
Limits:	X(-0.000, 24.042)	Y(-24.042, 0.000)	Z(-50.000, 18.000)
Plot 3:	Date: 2013-10-31	Time: 16:49:20	Job PJQUWE (STPLOT 4.7)

COMPANY: InnWind
PROJECT: Reference Jacket
SUBJECT: 4-LEG, 4-STOREY, Characteristic soil , LOWEST WATER LEVEL , 40.00

Hannemanns Alle 53
DK 2300 Copenhagen S

Tel: +45 5161 1000
Fax: +45 5161 1001

Web: www.ramboll.com/wind
Email: info@ramboll.com

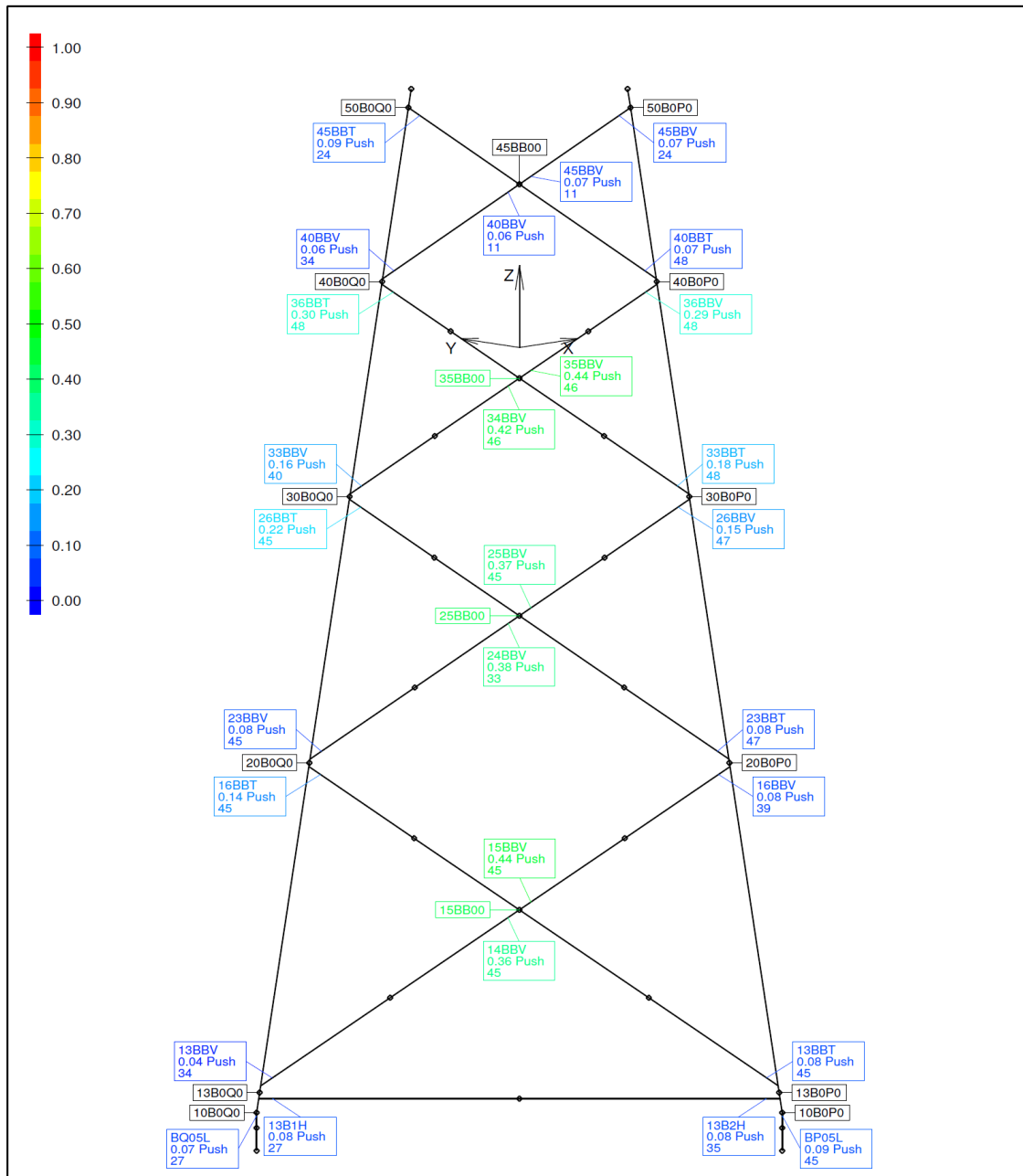

Tubular Joint Stress Check, Maximum Utilization Ratios, Limit = 1.00
 Jacket Side B - View from outside jacket

Ramboll Wind

Direction:	X: 0.699	Y: 0.699	Z: -0.151
Limits:	X(-24.042, -0.000)	Y(-24.042, 0.000)	Z(-50.000, 18.000)
Plot 2:	Date: 2013-10-31	Time: 16:49:20	Job PJQUWE (STPLOT 4.7)

COMPANY: InnWind
 PROJECT: Reference Jacket
 SUBJECT: 4-LEG, 4-STOREY, Characteristic soil , LOWEST WATER LEVEL , 40.00

Hannemanns Alle 53
 DK 2300 Copenhagen S

Tel: +45 5161 1000
 Fax: +45 5161 1001

Web: www.ramboll.com/wind
 Email: info@ramboll.com



APPENDIX 4 – FLS FATIGUE LIVES

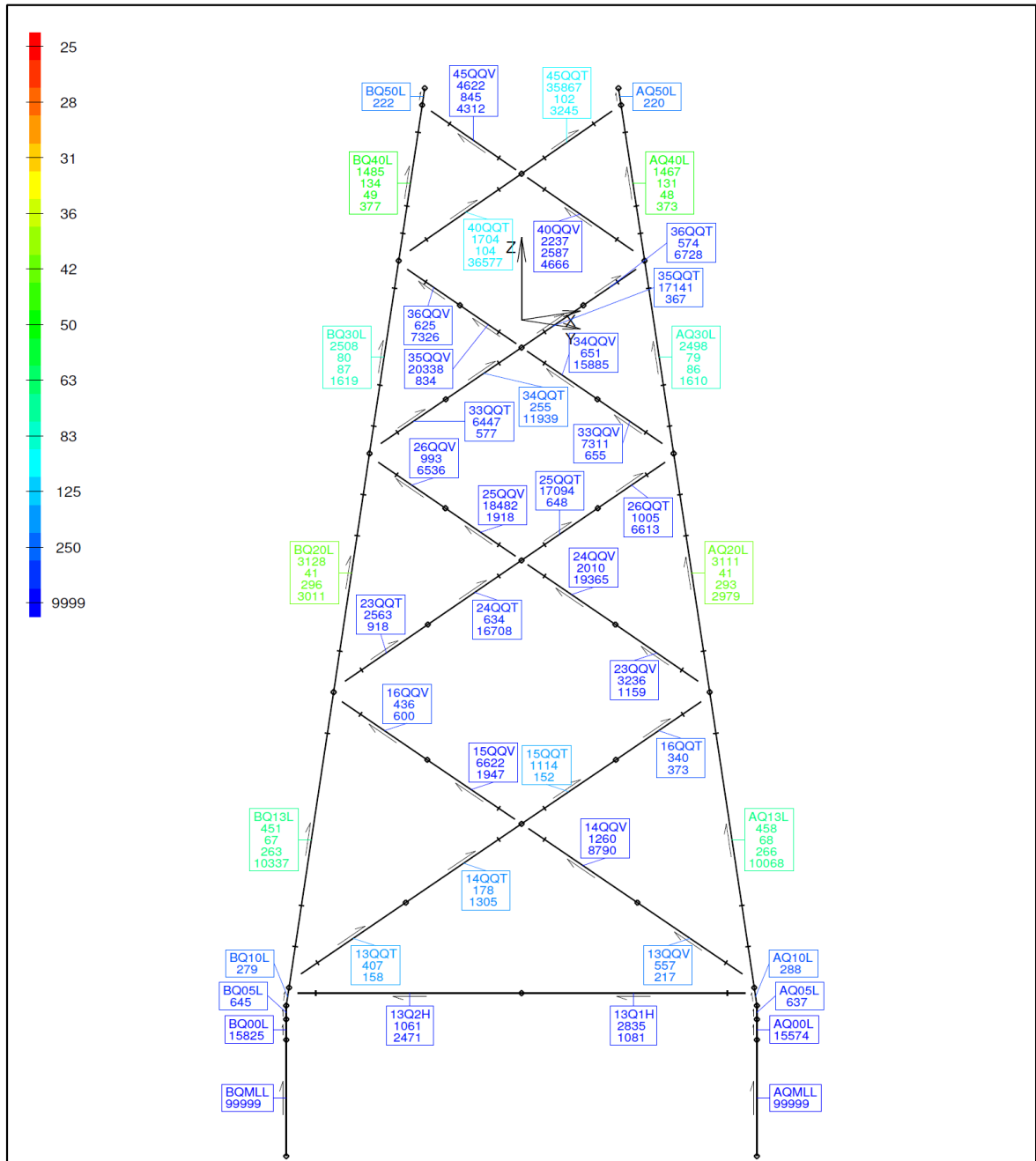

Element Fatigue Lives, Ratio Type FALI, Limit = 25
Jacket Row Q

Ramboll Offshore Wind

Direction:	X:-0.699	Y: 0.699	Z: 0.151
Limits:	X(-24.042, 0.000)	Y(0.000, 24.042)	Z(-58.500, 18.000)
Plot 4:	Date: 2013-10-18	Time: 09:38:03	Job OQJPJO (STPLOT 4.7)

COMPANY: InnWind
PROJECT: Reference Jacket
SUBJECT : 2 SIDED CIRCUMFERENTIAL WELDS, NO GRINDING (D-CURVE)

Willemoesgade 2
DK 6700 Esbjerg

Tel: +45 5161 1000
Fax: +45 5161 1001

Web: www.ramboll.com/wind
E-mail: info@ramboll.com

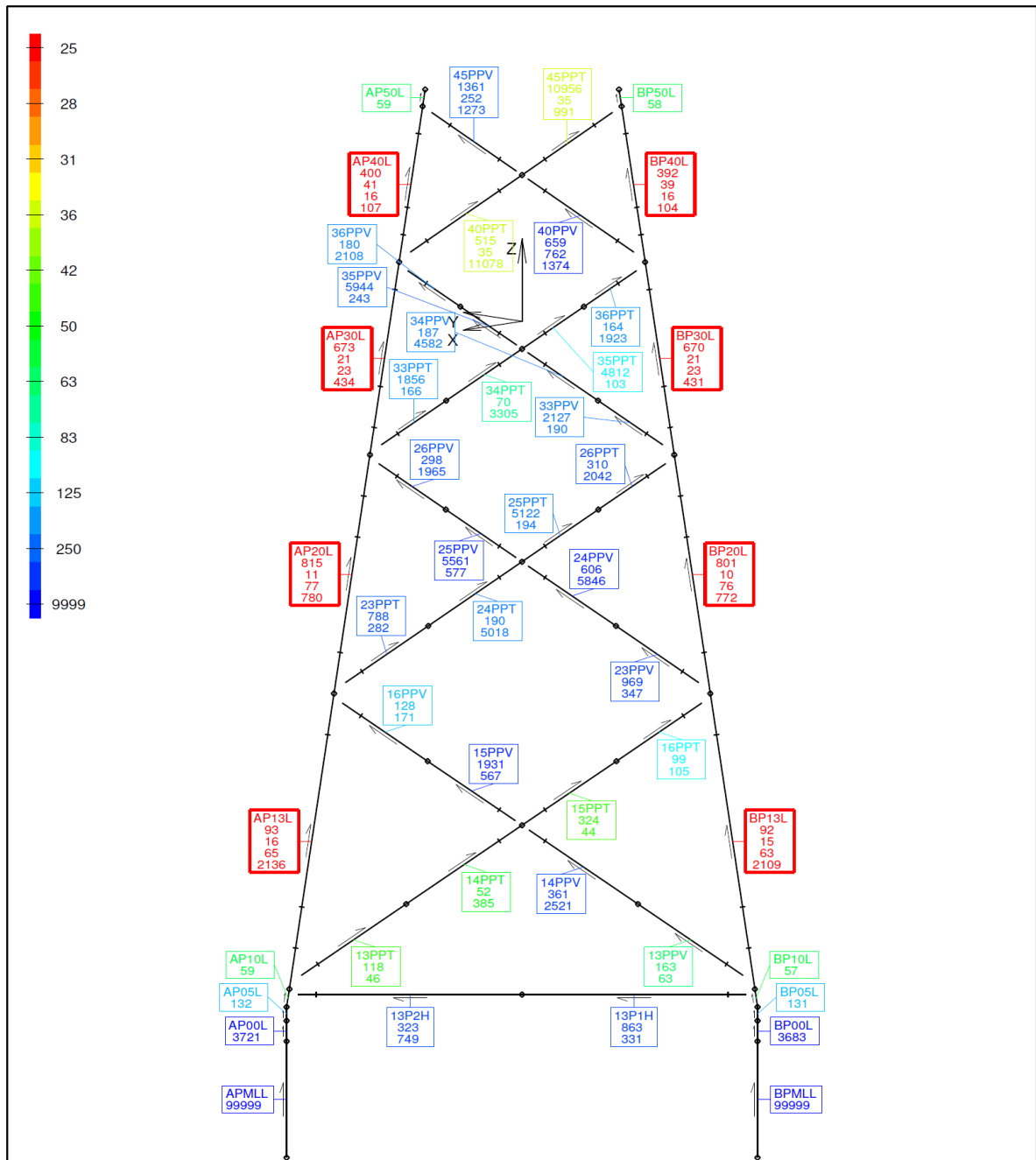

Element Fatigue Lives, Ratio Type FAIL, Limit = 25
Jacket Row P

Ramboll Offshore Wind

Direction:	X: 0.699	Y: -0.699	Z: 0.151
Limits:	X(-0.000, 24.042)	Y(-24.042, 0.000)	Z(-58.500, 18.000)
Plot 3:	Date: 2013-10-18	Time: 09:38:11	Job OQJQCH (STPLOT 4.7)

COMPANY: InnWind
PROJECT: Reference Jacket
SUBJECT : 1 SIDED CIRCUMFERENTIAL WELDS, NO GRINDING (F-CURVE)

Willemoesgade 2
DK 6700 Esbjerg

Tel: +45 5161 1000
Fax: +45 5161 1001

Web: www.ramboll.com/wind
E-mail: info@ramboll.com

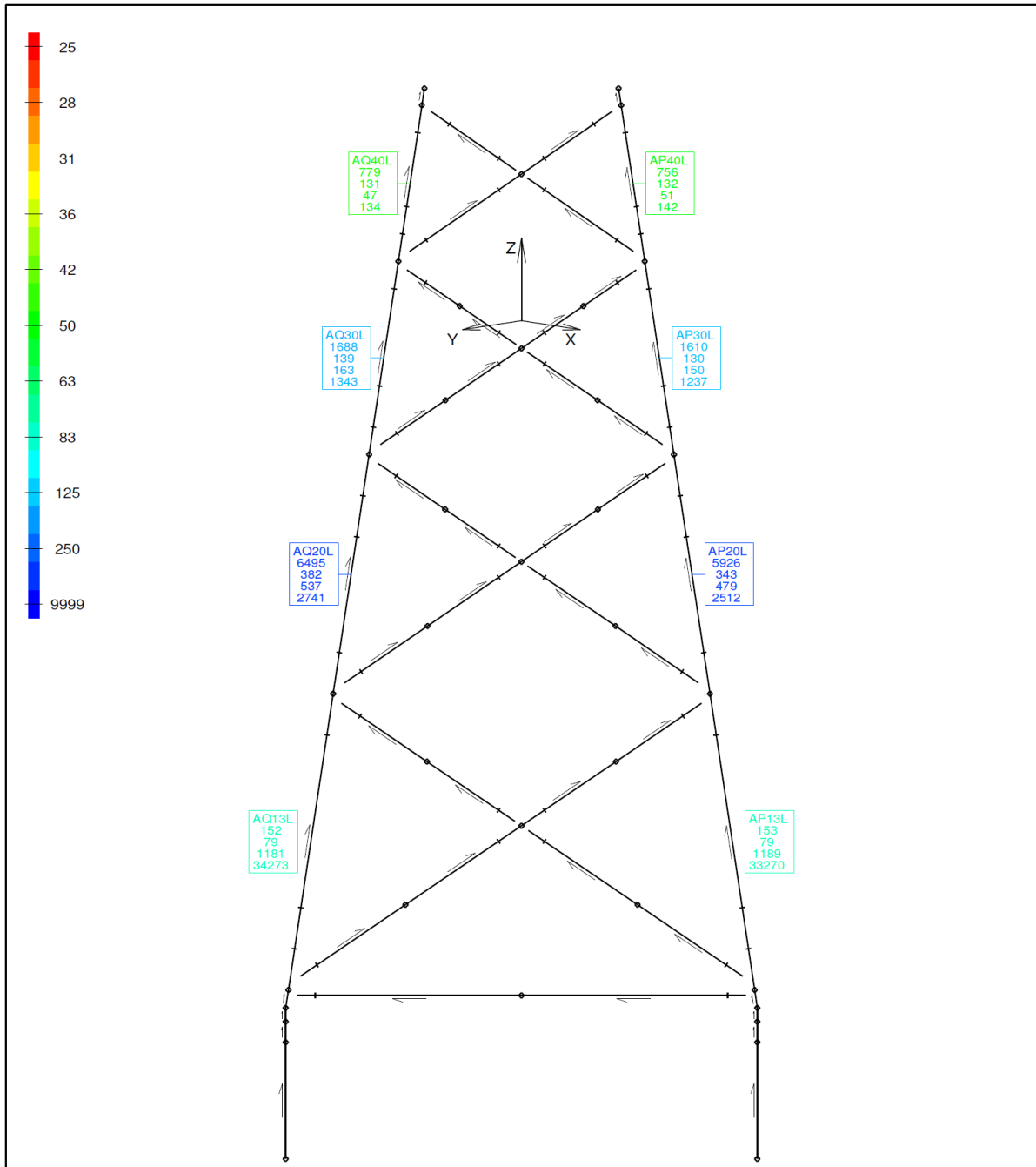

Element Fatigue Lives, Ratio Type FALI, Limit = 25
 Jacket Row A

Ramboll Offshore Wind

Direction:	X: 0.699	Y: 0.699	Z: 0.151
Limits:	X(0.000, 24.042)	Y(0.000, 24.042)	Z(-58.500, 18.000)
Plot 1:	Date: 2013-10-18	Time: 09:39:50	Job OQJQDT (STPLOT 4.7)

COMPANY: InnWind
 PROJECT: Reference Jacket
 SUBJECT : ATTACHMENTS (D-CURVE SCF)

Willemoesgade 2
 DK 6700 Esbjerg

Tel: +45 5161 1000
 Fax: +45 5161 1001

Web: www.ramboll.com/wind
 E-mail: info@ramboll.com

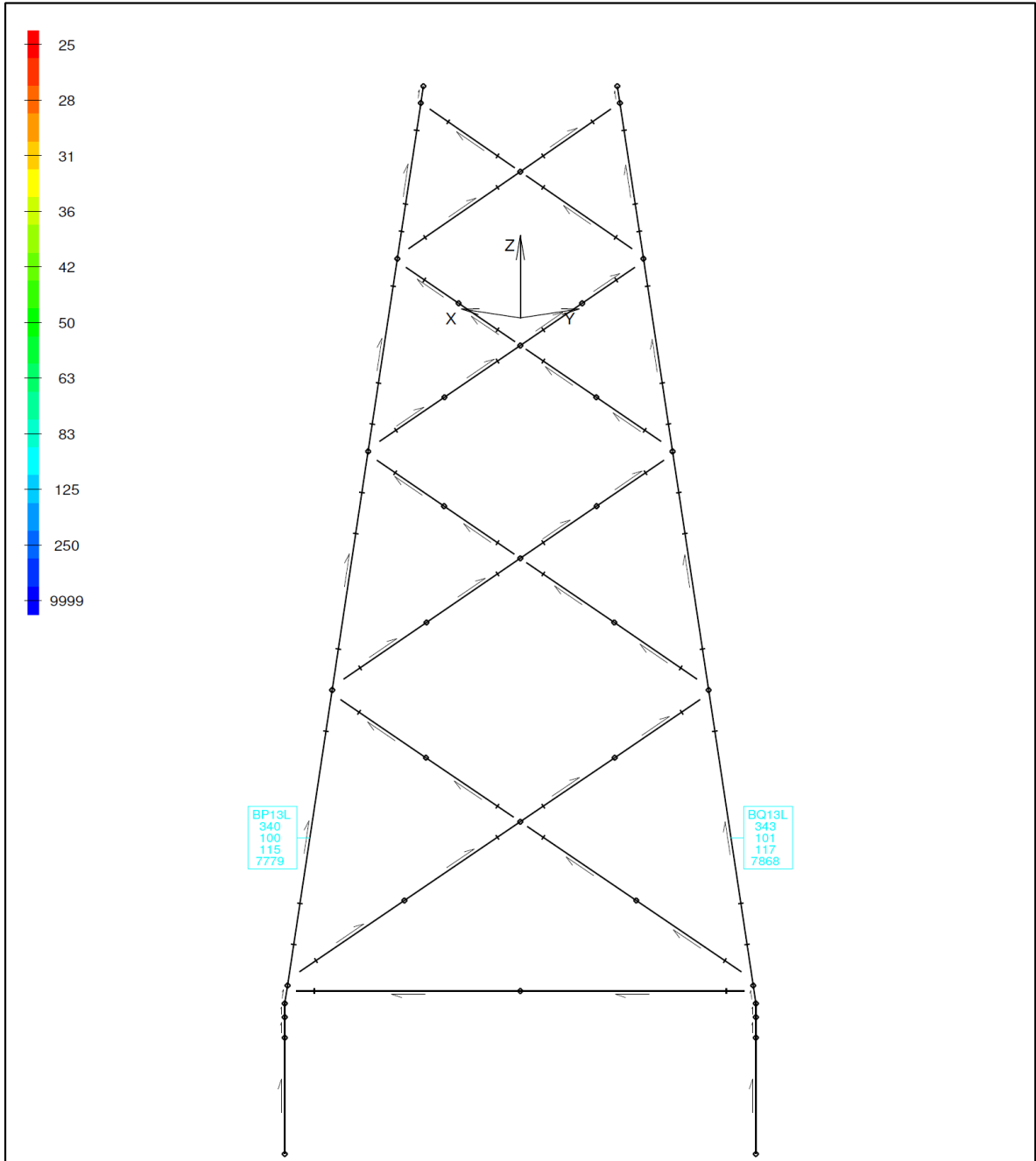

Element Fatigue Lives, Ratio Type FALL, Limit = 25
Jacket Row B

Ramboll Offshore Wind

Direction: X: -0.699	Y: -0.699	Z: 0.151
Limits: X(-24.042, -0.000)	Y(-24.042, 0.000)	Z(-58.500, 18.000)
Plot 2: Date: 2013-10-18	Time: 09:41:28	Job OQJQVX (STPLOT 4.7)

COMPANY: InnWind
PROJECT: Reference Jacket
SUBJECT : J-Tube Hole (B2-CURVE)

Willemoesgade 2 DK 6700 Esbjerg	Tel: +45 5161 1000 Fax: +45 5161 1001	Web: www.ramboll.com/wind E-mail: info@ramboll.com
------------------------------------	--	---

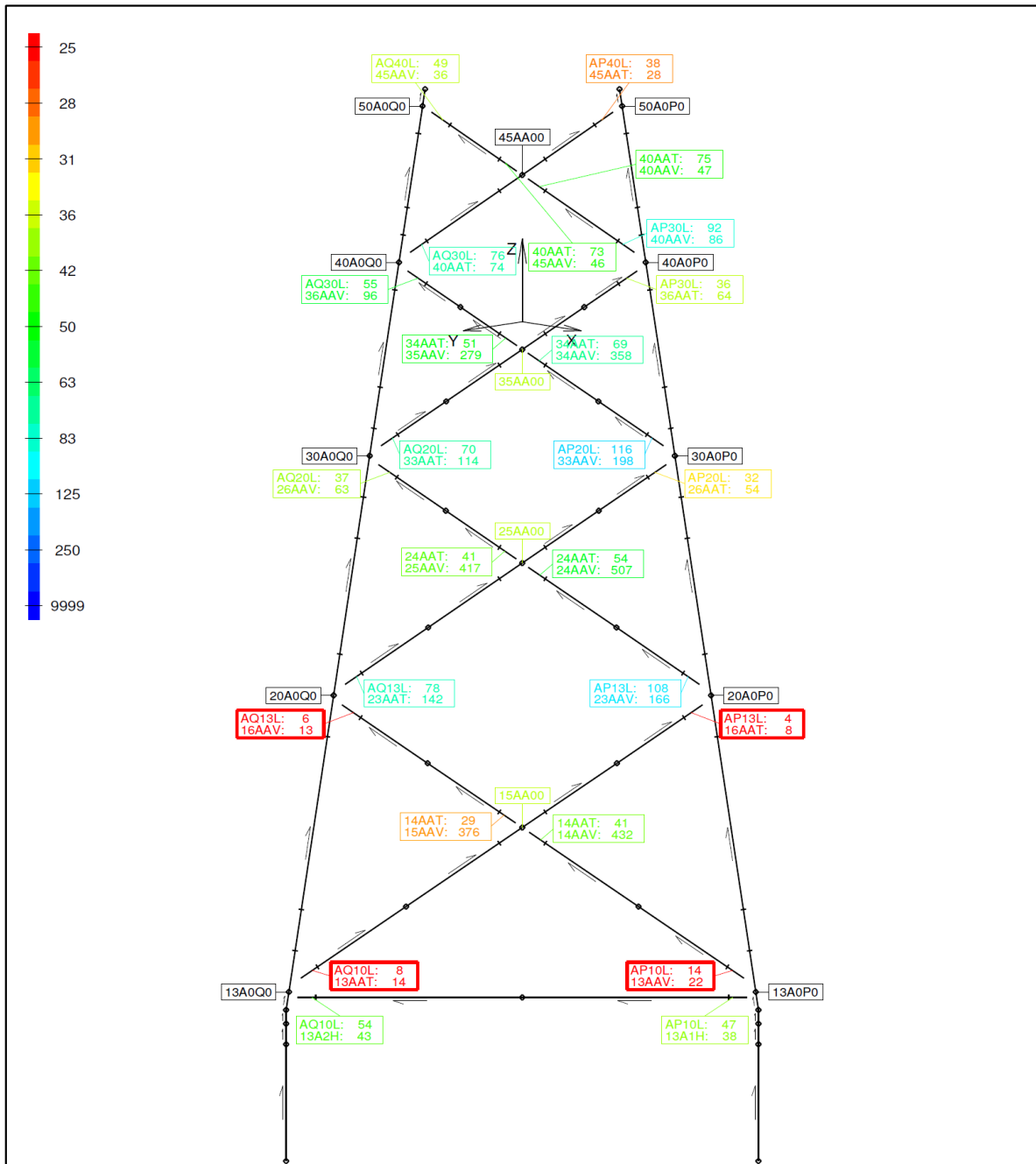

Tubular Joint Fatigue Lives, Ratio Type FALI, Limit = 25
Jacket Row A

Ramboll Offshore Wind

Direction:	X: 0.699	Y: 0.699	Z: 0.151
Limits:	X(0.000, 24.042)	Y(0.000, 24.042)	Z(-58.500, 18.000)
Plot 1:	Date: 2013-10-18	Time: 09:43:03	Job OQJRNX (STPLOT 4.7)

COMPANY: InnWind
PROJECT: Reference Jacket
SUBJECT : JOINTS AS-BUILD (T-CURVE)

Willemoesgade 2 DK 6700 Esbjerg	Tel: +45 5161 1000 Fax: +45 5161 1001	Web: www.ramboll.com/wind E-mail: info@ramboll.com
------------------------------------	--	---

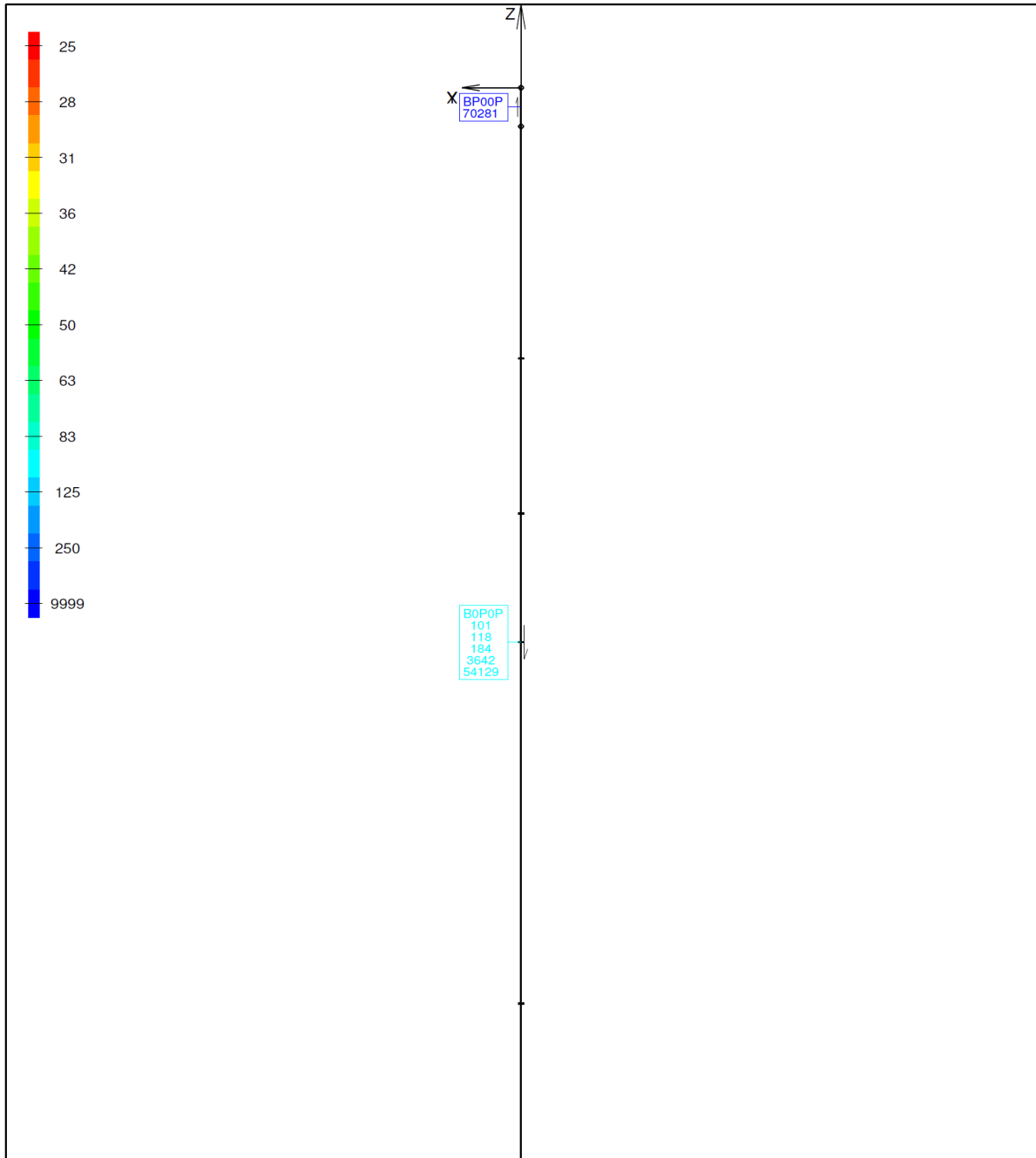

Element Fatigue Lives, Ratio Type FALI, Limit = 25
 Pile BP

Ramboll Offshore Wind

Direction:	X: 0.707	Y:-0.707	Z: 0.000
Limits:	X(-0.000, -0.000)	Y(-24.042, -24.042)	Z(-90.000, -48.500)
Plot 7:	Date: 2013-10-18	Time: 09:38:03	Job OQJPJO (STPLOT 4.7)

COMPANY: InnWind
 PROJECT: Reference Jacket
 SUBJECT : 2 SIDED CIRCUMFERENTIAL WELDS, NO GRINDING (D-CURVE)

Willemoesgade 2
 DK 6700 Esbjerg

Tel: +45 5161 1000
 Fax: +45 5161 1001

Web: www.ramboll.com/wind
 E-mail: info@ramboll.com



APPENDIX 5 – DESIGN LOAD CASES

Design Load Case (DLC)	1.2					
Operation conditions	Power production					
Wind conditions	Normal Turbulance Model; $V_{in} < V_{hub} < V_{out}$					
Sea conditions	Normal sea state, no current, MSL + 10% of tidal range					
Type of analysis	Fatigue					
Partial safety factors	Fatigue					
Description of Simulations:						
File name	Wind conditions		Wave conditions		Yaw error	Occurance [hours/year]
	Mean wind speed [m/s]	Longitudinal Turbulance Intensity [%]	Significant wave height [m]	Peak spectral period [T_p]		
1.2axy1-6	4	20.40	1.10	5.88	-8 deg	874.7
1.2bxy1-6	6	17.50	1.18	5.76	-8 deg	992.8
1.2cxy1-6	8	16.00	1.31	5.67	-8 deg	1181.8
1.2dxy1-6	10	15.20	1.48	5.74	-8 deg	1076.3
1.2exy1-6	12	14.60	1.70	5.88	-8 deg	1137.2
1.2fxy1-6	14	14.20	1.91	6.07	-8 deg	875.6
1.2gxy1-6	16	13.90	2.19	6.37	-8 deg	764.7
1.2hxy1-6	18	13.60	2.47	6.71	-8 deg	501.3
1.2ixy1-6	20	13.40	2.76	6.99	-8 deg	336.0
1.2jxy1-6	22	13.30	3.09	7.40	-8 deg	289.4
1.2kxy1-6	24	13.10	3.42	7.80	-8 deg	130.4

Comments:

- Three dimensional three component Kaimal turbulent wind field (10 min sample).
- First 200s of output discarded to allow initial transients to decay
- Two turbulent wind seeds per wind speed bin (indexed 1-2)
- Simulations run with 12 wind directions in 30deg sectors around the structure from 0 - 330deg (indexed x=a-l)
- Simulations run with wind/wave misalignment from -30 to 120deg relative to wind direction in 30deg intervals (indexed y=a-f)
- Wind gradient exponent (exponential model), $\alpha = 0.14$
- Supervisory control is disabled for these simulations

Design Load Case (DLC)		6.4				
Operation conditions		Parked (stand still or idling)				
Wind conditions		Normal Turbulance Model; $V_{hub} < 0.7 V_{ref}$				
Sea conditions		Normal sea state, no current, MSL + 10% of tidal range				
Type of analysis		Fatigue				
Partial safety factors		Fatigue				
Description of Simulations:						
File name	Wind conditions		Wave conditions		Yaw error	Occurance [hours/year]
	Mean wind speed [m/s]	Longitudinal Turbulance Intensity [%]	Significant wave height [m]	Peak spectral period [T_p]		
6.4axy1-6	2	29.20	1.07	6.03	0 deg	434.3
6.4bxy1-6	30	11.80	4.46	8.86	0 deg	149.0

Comments:

- Three dimensional three component Kaimal turbulent wind field (10 min sample)
- First 200s of output discarded to allow initial transients to decay
- Six turbulent wind seeds per wind speed bin (indexed 1-2)
- Simulations run with 12 wind directions in 30deg sectors around the structure from 0 - 330deg (indexed x=a-l)
- Simulations run with wind/wave misalignment from -30 to 120deg relative to wind direction in 30deg intervals (indexed y=a-f)
- Wind gradient exponent (exponential model), $\alpha = 0.14$
- All blades at idling pitch angle of 90 deg
- Supervisory control is disabled for these simulations

Design Load Case (DLC)	2.3				
Operation conditions	Power production plus loss of electrical grid connection				
Wind conditions	Extreme operating gust (EOG)				
Sea conditions	Normal wave height, normal current model, MSL				
Type of analysis	Ultimate				
Partial safety factors	Abnormal				
Description of Simulations:					
File name	Wind conditions		Wave conditions		Yaw error
	Mean wind speed [m/s]	Longitudinal Turbulence Intensity [%]	Significant wave height [m]	Peak spectral period [T _p]	
2.3axy	10	0.00	1.10	4.68	0 deg
2.3bxy	12	0.00	1.58	5.62	
2.3cxy	14	0.00	2.15	6.55	
2.3hxy	24	7.98	6.32	11.23	

Comments:

- Steady wind with transient gust (gust period = 10.5s)
- One minute simulations
- First 200s of output discarded to allow initial transients to decay
- Simulations run with support structure at 0deg orientation
- Gust occurs 10s into simulation
- Wind gradient exponent (exponential model), $\alpha = 0.14$
- Normal current of 0.6 m/s applied
- Grid loss occurs at gust start, minimum wind speed, maximum gust acceleration and maximum wind speed (indexed $x=a-d$)
- Starting azimuth angle was constant 0 deg

Design Load Case (DLC)	6.1a					
Operation conditions	Idling					
Wind conditions	Extreme wind model (turbulent) ($V_{hub} = V_{50}$)					
Sea conditions	Extreme sea state ($H_s = H_{s50}$), extreme current model (50y return period), EWLRL					
Type of analysis	Ultimate					
Partial safety factors	Normal					
Description of Simulations:						
	Wind conditions		Wave conditions			
File name	Mean wind speed [m/s]	Longitudinal Turbulance Intensity [%]	Significant wave height [m]	Peak spectral period [T_p]	Yaw error	Wind/wave misalignment
6.1	42.73	11.00	9.40	13.70	-8,0,8 deg	0 deg

Comments:

- Three dimensional three component Kaimal turbulent wind field (10 min sample).
- First 200s of output discarded to allow initial transients to decay
- Six turbulent wind seeds per wind speed bin (indexed 1-6)
- Simulations run with support structure at 0deg orientation
- Wind gradient exponent (exponential model), $\alpha = 0.11$
- Extreme current with 50-year return period of 1.2 m/s applied

Design Load Case (DLC)	6.2a					
Operation conditions	Idling with grid loss					
Wind conditions	Extreme wind model (turbulent) ($V_{hub} = V_{50}$)					
Sea conditions	Extreme sea state ($H_s = H_{s50}$), extreme current model (50y retrun period), EWLR					
Type of analysis	Ultimate					
Partial safety factors	Abnormal					
Description of Simulations:						
	Wind conditions		Wave conditions			
File name	Mean wind speed [m/s]	Longitudinal Turbulance Intensity [%]	Significant wave height [m]	Peak spectral period [T_p]	Yaw error	Wind/wave misalignmen t
6.2	42.73	11.00	9.40	13.70	0 deg	0 deg

Comments:

- Three dimensional three component Kaimal turbulent wind field (10 min sample).
- First 200s of output discarded to allow initial transients to decay
- Six turbulent wind seeds per wind speed bin (indexed 1-6)
- Wind gradient exponent (exponential model), $\alpha = 0.11$
- The wind direction is swepted from 0 to 180 deg with 30 deg step



APPENDIX 6 – SOIL PROFILE

DESIGN PARAMETERS FOR SOIL IN01 WITH PILE A0P0P											
depth (m)	Soil type	γ' (kN/m ³)	I_p (%)	q_u (MPa)	ϕ (deg)	c_u (kPa)	E (MPa)	ϵ_{50} (%)	t_c (kPa)	t_t (kPa)	q (MPa)
0.0	SAND	9.00			35.0		3.0		0.0	0.0	0.0
2.0	SAND	9.00			35.0		7.1		4.2	4.2	0.3
9.0	SAND	9.00			35.0		13.1		22.9	22.9	1.6
10.0	SAND	9.00			35.0		18.2		39.5	39.5	2.8
15.0	SAND	9.00			35.0		20.8		52.0	52.0	3.7
15.0	SAND	10.00			35.0		24.9		73.9	73.9	5.3
20.0	SAND	10.50			35.0		27.8		91.5	91.5	6.6
22.5	SAND	11.00			35.0		30.9		106.3	106.3	8.2
29.0	SAND	11.00			35.0		34.7		115.0	115.0	10.3
34.0	SAND	11.00			35.0		37.4		115.0	115.0	11.6
38.0	SAND	11.00			35.0		39.1		115.0	115.0	12.0
40.0	SAND	11.00			35.0		50.3		115.0	115.0	12.0
90.0	SAND	11.00			35.0		50.3		115.0	115.0	12.0

scale changed ↓

γ' : Submerged unit weight
 I_p : Plasticity index
 q_u : Unconfined compression strength
 ϕ : Characteristic angle of internal friction
 c_u : Characteristic undrained shear strength
 E : Modulus of elasticity
 ϵ_{50} : Strain which occurs at one-half of the maximum stress in laboratory undrained compression test
 t_c : Unit skin friction, compression
 t_t : Unit skin friction, tension
 q : Unit tip resistance, compression

Design code: DNV-J101
 Partial coefficient on angle of internal friction: 1.00
 Partial coefficient on undrained shear strength: 1.00
 Partial coefficient on axial bearing capacity: 1.00

Scour: Local scour: 0.0 m
 Global scour: 0.0 m
 Scour angle: 0.0 deg

 Pile tip depth: 40.00 m
 Pile tip diameter: 2438.0 mm
 Pile tip thickness: 32.0 mm

Ramboll Wind

Subject: InnWind Soil Profile

Prepared: TVB

Checked: BJOS

Approved: TIMF

Program: ROSA 4.71

Rev. 0 Date: 2013-09-25

Hannemanns Alle 53
DK 2300 Copenhagen S

Tel: +45 5161 1000
Fax: +45 5161 1001

Web: www.ramboll.com/wind
Email: info@ramboll.com

4X4L_116_4X4L_STIF_ro_A0P0P.PS

© Copyright Ramboll Oil & Gas



APPENDIX 7 – SUPERLEMENT OF FOUNDATION (EXCLUDING TOWER)

Superelement description: Super Element at Interface

Height for interface point: 26m wrt. MSL

IMass matrix (units kg, kgm, kgm²)

Deflection X	Deflection Y	Deflection Z	Rotation X	Rotation Y	Rotation Z
1.35E+06	-2.92E+00	-7.99E+02	1.36E+04	-1.58E+07	-2.51E+04
-2.92E+00	1.35E+06	-5.50E+02	1.58E+07	1.37E+04	3.75E+04
-7.99E+02	-5.50E+02	9.86E+05	7.68E+03	-1.39E+04	-2.41E+04
1.36E+04	1.58E+07	7.68E+03	2.38E+08	1.02E+03	5.18E+05
-1.58E+07	1.37E+04	-1.39E+04	1.02E+03	2.38E+08	3.83E+05
-2.51E+04	3.75E+04	-2.41E+04	5.18E+05	3.83E+05	8.34E+07

IStiffness matrix (units N/m, N, Nm)

Deflection X	Deflection Y	Deflection Z	Rotation X	Rotation Y	Rotation Z
1.05E+08	-1.12E-01	-2.75E-02	8.53E+05	-1.83E+09	-1.18E-02
-1.12E-01	1.05E+08	-1.06E-03	1.83E+09	8.53E+05	1.01E+01
-2.75E-02	-1.06E-03	1.74E+09	-2.13E-02	6.74E-01	-3.48E+06
8.53E+05	1.83E+09	-2.13E-02	1.95E+11	1.09E+01	1.98E+02
-1.83E+09	8.53E+05	6.74E-01	1.09E+01	1.95E+11	3.71E-01
-1.18E-02	1.01E+01	-3.48E+06	1.98E+02	3.71E-01	3.20E+10

IDamping matrix (units kg/s, kgm/s, kgm²/s)

Deflection X	Deflection Y	Deflection Z	Rotation X	Rotation Y	Rotation Z
1.39E+05	-4.16E-02	-1.14E+01	1.17E+03	-2.32E+06	-3.57E+02
-4.16E-02	1.39E+05	-7.82E+00	2.32E+06	1.17E+03	5.34E+02
-1.14E+01	-7.82E+00	2.00E+06	1.09E+02	-1.97E+02	-4.31E+03
1.17E+03	2.32E+06	1.09E+02	2.26E+08	1.45E+01	7.37E+03
-2.32E+06	1.17E+03	-1.97E+02	1.45E+01	2.26E+08	5.45E+03
-3.57E+02	5.34E+02	-4.31E+03	7.37E+03	5.45E+03	3.76E+07

Please see Figure 2 for the definition of the global coordinate system